

Catalog | June 2016

Low voltage General performance motors

With expertise, and a comprehensive portfolio of products and life-cycle services, we help value-minded industrial customers improve their energy efficiency and productivity.

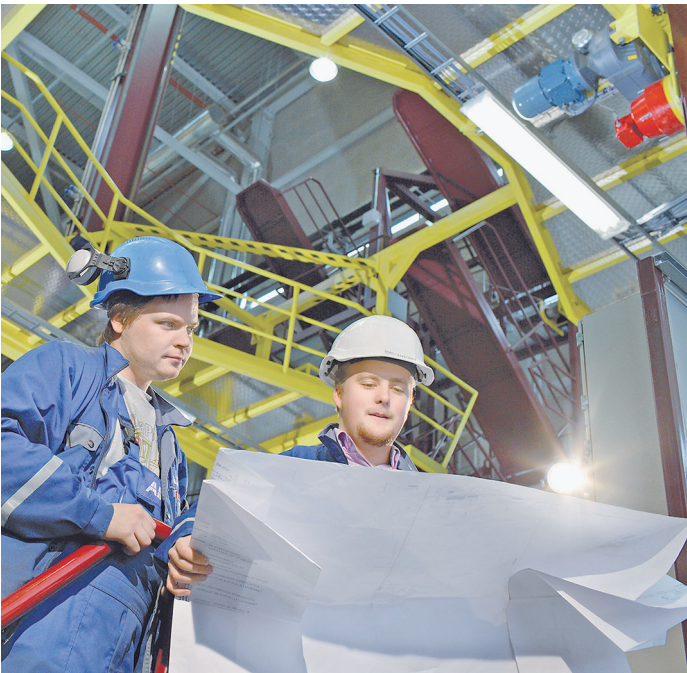

Low voltage General performance motors

Sizes 56 to 355, 0.06 to 355 kW

General information	4
Mounting arrangements	8
Cooling	9
Degrees of protection: IP code/IK code	10
Insulation	11
Voltage and frequency	12
Cast iron motors IE3 and IE2 M2BAX	14
Ordering information	14
Rating plates	15
Technical data IE3 and IE2	16
Variant codes	22
Mechanical design	24
Dimension drawings	30
Motors in brief	31
Motors in brief	32
Cast iron motors IE2 M2BA	36
Ordering information	36
Technical data	37
Variant codes	40
Dimension drawings	42
Motors in brief	43
Aluminum motors IE2 M2AA	48
Ordering information	48
Variant codes	52
Dimension drawings	54
Motors in brief	55
Total product offering	57
Life cycle services and support	58

International motor efficiency standards

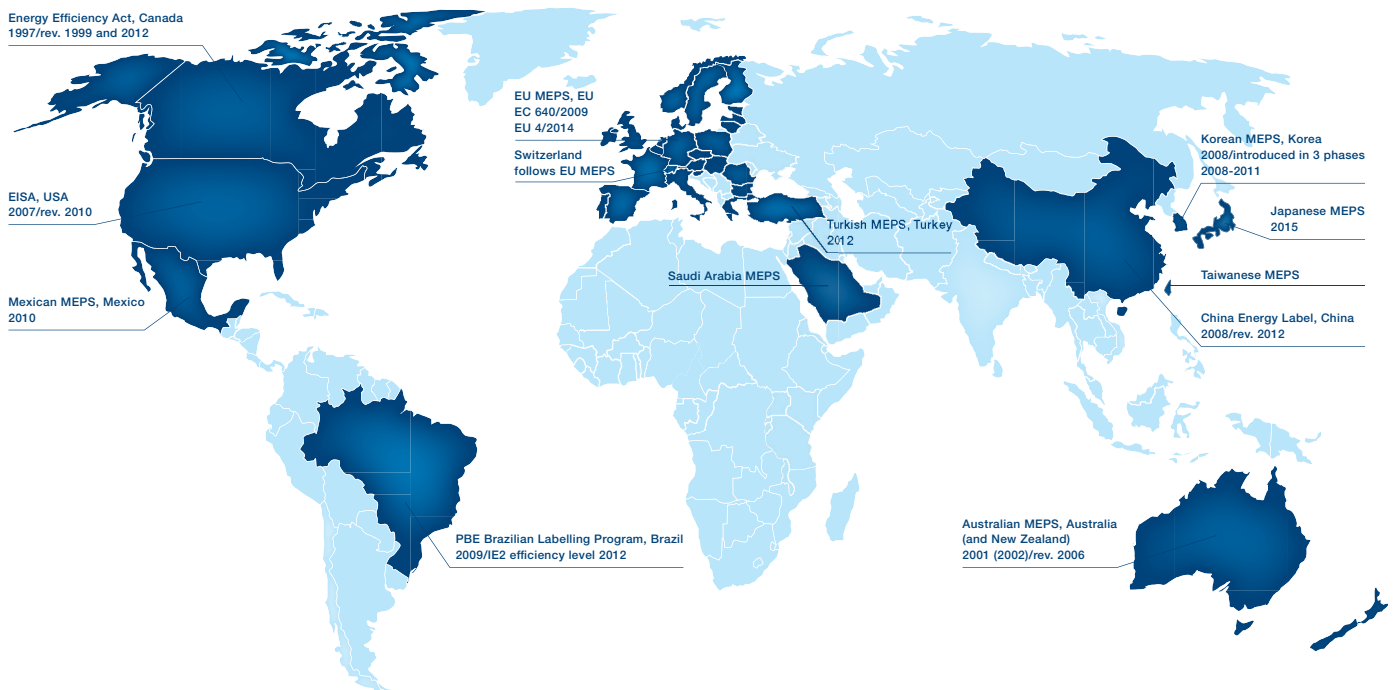

Since the validation of IEC/EN 60034-30:2008 and its refined version IEC/EN 60034-30-1: 2014, a worldwide energy efficiency classification system has existed for low voltage three-phase asynchronous motors. This system increases the level of harmonization in efficiency regulations around the world and also covers motors for explosive atmospheres. IEC/EN 60034-30-1: 2014 defines International Efficiency (IE) classes for single speed, three-phase, 50 and 60 Hz induction motors. The standard is part of an effort to unify motor testing procedures as well as efficiency and product labeling requirements to enable motor purchasers worldwide to easily recognize premium efficiency products. The efficiency levels defined in IEC/EN 60034-30-1 are based on test methods specified in IEC/EN 60034-2-1 which has been updated to edition 2.0, 2014-06.

To promote transparency in the market, IEC 60034-30 states that both the efficiency class and efficiency value must be shown on the motor rating plate and in product documentation. The documentation must clearly indicate the efficiency testing method used as the different methods can produce differing results.

Minimum energy performance standards

While the IEC sets guidelines for motor testing and efficiency classes, the organization does not regulate efficiency. The biggest drivers for mandatory Minimum Energy Performance Standard (MEPS) levels for electric motors are global climate change, government targets to cut the CO₂ emissions and rising electricity demand, especially in developing countries. The whole value chain, from manufacturer up to end user, must be aware of the legislation in order to meet local requirements and additionally save energy and reduce carbon footprint.

Harmonized standards and the increasing adoption of MEPS around the world are good news. However, it is important to remember that harmonization is an ongoing process. Even though MEPS are already in effect in several regions, they are evolving and they differ in terms of scope and requirements. At the same time, new countries are planning to adopt their own MEPS. To get the latest information please visit www.abb.com/motors&generators/energyefficiency.

IEC/EN 60034-30-1: 2014

IEC/EN 60034-30-1:2014 defines four International Efficiency (IE) classes for single speed electric motors that are rated according to IEC 60034-1 or IEC 60079-0 (explosive atmospheres) and designed for operation on sinusoidal voltage.

- IE4 = Super premium efficiency
- IE3 = Premium efficiency, identical to 'NEMA Premium' in the USA for 60 Hz
- IE2 = High efficiency, identical to EPAact in the USA for 60 Hz
- IE1 = Standard efficiency

Efficiency levels defined in IEC/EN 60034-30-1 are based on test methods specified in IEC 60034-2-1.

IEC/EN 60034-30-1 covers power range 120 W to 1000 kW. All technical constructions of electric motors are covered as long as they are rated for direct on-line operation. The coverage of the standard includes:

- Single speed electric motors (single and three-phase), 50 and 60 Hz
- 2, 4, 6 and 8 poles
- Rated output P_N from 0.12 kW to 1000 kW
- Rated voltage U_N above 50 V up to 1 kV
- Motors, capable of continuous operation at their rated power with a temperature rise within the specified insulation temperature class
- Motors, marked with any ambient temperature within the range of -20 °C to +60 °C
- Motors, marked with an altitude up to 4000 m above sea level

The following motors are excluded from IEC/EN 60034-30-1:

- Single-speed motors with 10 or more poles or multi-speed motors
- Motors completely integrated into a machine (for example, pump, fan or compressor) that cannot be tested separately from machine
- Brake motors, when the brake can not be dismantled or separately fed

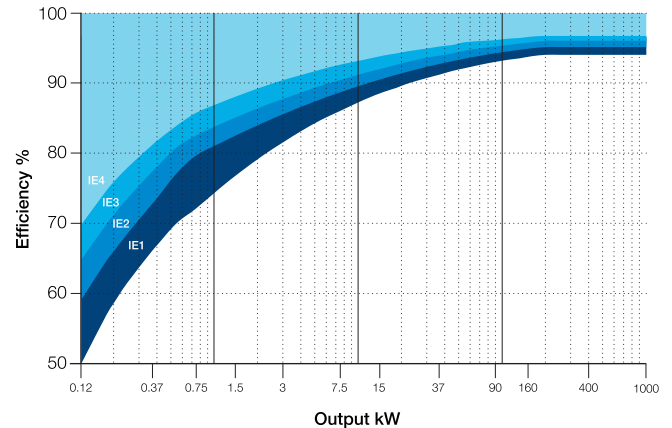

IE Classes - 4-pole motors

ABB and efficiency standards

ABB determines efficiency values according to IEC 60034-2-1 using the low uncertainty method (i.e. indirect method), with additional load losses determined by measurement.

As the world market leader, ABB offers the largest range of LV motors available. It has long advocated the need for efficiency in motors, and high efficiency products have formed the core of its portfolio for many years. The core of ABB's Process performance range is based on full range in IE2 and IE3 motors - with many available from stock. We also supply IE4 motors for additional energy savings.

Minimum efficiency values defined in IEC/EN 60034-30-1: 2014 (reference values at 50 Hz, based on test methods specified in IEC 60034-2-1 which has been updated to edition 2.0, 2014-06).

Output kW	IE1 Standard efficiency				IE2 High efficiency				IE3 Premium efficiency				IE4 Super Premium efficiency			
	2 pole	4 pole	6 pole	8 pole	2 pole	4 pole	6 pole	8 pole	2 pole	4 pole	6 pole	8 pole	2 pole	4 pole	6 pole	8 pole
0.12	45.0	50.0	38.3	31.0	53.6	59.1	50.6	39.8	60.8	64.8	57.7	50.7	66.5	69.8	64.9	62.3
0.18	52.8	57.0	45.5	38.0	60.4	64.7	56.6	45.9	65.9	69.9	63.9	58.7	70.8	74.7	70.1	67.2
0.20	54.6	58.5	47.6	39.7	61.9	65.9	58.2	47.4	67.2	71.1	65.4	60.6	71.9	75.8	71.4	68.4
0.25	58.2	61.5	52.1	43.4	64.8	68.5	61.6	50.6	69.7	73.5	68.6	64.1	74.3	77.9	74.1	70.8
0.37	63.9	66.0	59.7	49.7	69.5	72.7	67.6	56.1	73.8	77.3	73.5	69.3	78.1	81.1	78.0	74.3
0.40	64.9	66.8	61.1	50.9	70.4	73.5	68.8	57.2	74.6	78.0	74.4	70.1	78.9	81.7	78.7	74.9
0.55	69.0	70.0	65.8	56.1	74.1	77.1	73.1	61.7	77.8	80.8	77.2	73.0	81.5	83.9	80.9	77.0
0.75	72.1	72.1	70.0	61.2	77.4	79.6	75.9	66.2	80.7	82.5	78.9	75.0	83.5	85.7	82.7	78.4
1.1	75.0	75.0	72.9	66.5	79.6	81.4	78.1	70.8	82.7	84.1	81.0	77.7	85.2	87.2	84.5	80.8
1.5	77.2	77.2	75.2	70.2	81.3	82.8	79.8	74.1	84.2	85.3	82.5	79.7	86.5	88.2	85.9	82.6
2.2	79.7	79.7	77.7	74.2	83.2	84.3	81.8	77.6	85.9	86.7	84.3	81.9	88.0	89.5	87.4	84.5
3	81.5	81.5	79.7	77.0	84.6	85.5	83.3	80.0	87.1	87.7	85.6	83.5	89.1	90.4	88.6	85.9
4	83.1	83.1	81.4	79.2	85.8	86.6	84.6	81.9	88.1	88.6	86.8	84.8	90.0	91.1	89.5	87.1
5.5	84.7	84.7	83.1	81.4	87.0	87.7	86.0	83.8	89.2	89.6	88.0	86.2	90.9	91.9	90.5	88.3
7.5	86.0	86.0	84.7	83.1	88.1	88.7	87.2	85.3	90.1	90.4	89.1	87.3	91.7	92.6	91.3	89.3
11	87.6	87.6	86.4	85.0	89.4	89.8	88.7	86.9	91.2	91.4	90.3	88.6	92.6	93.3	92.3	90.4
15	88.7	88.7	87.7	86.2	90.3	90.6	89.7	88.0	91.9	92.1	91.2	89.6	93.3	93.9	92.9	91.2
18.5	89.3	89.3	88.6	86.9	90.9	91.2	90.4	88.6	92.4	92.6	91.7	90.1	93.7	94.2	93.4	91.7
22	89.9	89.9	89.2	87.4	91.3	91.6	90.9	89.1	92.7	93.0	92.2	90.6	94.0	94.5	93.7	92.1
30	90.7	90.7	90.2	88.3	92.0	92.3	91.7	89.8	93.3	93.6	92.9	91.3	94.5	94.9	94.2	92.7
37	91.2	91.2	90.8	88.8	92.5	92.7	92.2	90.3	93.7	93.9	93.3	91.8	94.8	95.2	94.5	93.1
45	91.7	91.7	91.4	89.2	92.9	93.1	92.7	90.7	94.0	94.2	93.7	92.2	95.0	95.4	94.8	93.4
55	92.1	92.1	91.9	89.7	93.2	93.5	93.1	91.0	94.3	94.6	94.1	92.5	95.3	95.7	95.1	93.7
75	92.7	92.7	92.6	90.3	93.8	94.0	93.7	91.6	94.7	95.0	94.6	93.1	95.6	96.0	95.4	94.2
90	93.0	93.0	92.9	90.7	94.1	94.2	94.0	91.9	95.0	95.2	94.9	93.4	95.8	96.1	95.6	94.4
110	93.3	93.3	93.3	91.1	94.3	94.5	94.3	92.3	95.2	95.4	95.1	93.7	96.0	96.3	95.8	94.7
132	93.5	93.5	93.5	91.5	94.6	94.7	94.6	92.6	95.4	95.6	95.4	94.0	96.2	96.4	96.0	94.9
160	93.8	93.8	93.8	91.9	94.8	94.9	94.8	93.0	95.6	95.8	95.6	94.3	96.3	96.6	96.2	95.1
200	94.0	94.0	94.0	92.5	95.0	95.1	95.0	93.5	95.8	96.0	95.8	94.6	96.5	96.7	96.3	95.4
250	94.0	94.0	94.0	92.5	95.0	95.1	95.0	93.5	95.8	96.0	95.8	94.6	96.5	96.7	96.5	95.4
315	94.0	94.0	94.0	92.5	95.0	95.1	95.0	93.5	95.8	96.0	95.8	94.6	96.5	96.7	96.6	95.4
355	94.0	94.0	94.0	92.5	95.0	95.1	95.0	93.5	95.8	96.0	95.8	94.6	96.5	96.7	96.6	95.4
400	94.0	94.0	94.0	92.5	95.0	95.1	95.0	93.5	95.8	96.0	95.8	94.6	96.5	96.7	96.6	95.4
450	94.0	94.0	94.0	92.5	95.0	95.1	95.0	93.5	95.8	96.0	95.8	94.6	96.5	96.7	96.6	95.4
500-1000	94.0	94.0	94.0	92.5	95.0	95.1	95.0	93.5	95.8	96.0	95.8	94.6	96.5	96.7	96.6	95.4

EU MEPS – Efficiency requirements for low voltage motors in Europe

Mandatory MEPS requirements

EU MEPS (European Minimum Energy Performance Standard) sets mandatory minimum efficiency levels for electric motors introduced into the European market. It is based on European Commission Regulation EC 640/2009 and an amendment passed in 2014, Regulation EU 4/2014.

MEPS scope

The MEPS scheme covers 2-, 4- and 6-pole single speed, three-phase induction motors in a power range 0.75 to 375 kW, rated up to 1000 V on the basis of continuous duty operation. The scheme is being implemented in three stages:

- Stage 1: 16 June 2011: Motors must meet the IE2 efficiency level
- Stage 2: 1 January 2015: Motors with a rated output of 7.5 - 375 kW must meet EITHER the IE3 efficiency level if driven direct-on-line OR the IE2 level if fitted with a variable speed drive
- Stage 3: 1 January 2017: Motors with a rated output of 0.75 - 375 kW must meet EITHER the IE3 efficiency level if driven direct-on-line OR the IE2 level if fitted with a variable speed drive

The amendment (Regulation EU 4/2014) did not change the scope of EU MEPS but it did change the details concerning which motors are excluded.

Efficiency testing methods

Motor losses and efficiency values in the EU MEPS scheme must be determined using the methods specified in standard IEC 60034-2-1:06-2014. International efficiency classes (IE4, IE3, IE2 and IE1) are defined in standard IEC 60034-30-1.

Compulsory efficiency levels

The table of minimum efficiency values on the previous page shows values according to IEC 60034-30-1:2014. Please note that this standard covers a wider range of motors than EU MEPS, which is still based on the previous standard (IEC 60034-30). Specifically, EU MEPS does not apply to 8-pole motors, or to motors rated below 0.75 or above 375 kW. IE1 motors have been excluded from the European market since EU MEPS came into force on 16 June 2011. Regulation EC 640/2009 required the following information on the motor rating plate and in motor documentation:

- Lowest nominal efficiency at 100%, 75% and 50% rated load
- Efficiency level (IE2, IE3 or IE4)
- Year of manufacture

These requirements were relaxed by amendment EU 4/2014 for small motors where the rating plate is too small to accommodate the full set of figures. In such cases manufacturers are now allowed to show only the efficiency for 100% rated load.

ABB and EU MEPS

At ABB we have long spoken out in favor of efforts to boost energy efficiency and reduce emissions. We play an active role in organizations that set efficiency standards, and we are happy to see MEPS being adopted in more and more countries around the world. We hope the authorities will maintain the momentum and take MEPS forward. IEC standards move fast, and active work is needed to bring the scope of EU MEPS into line with IEC/EN 60034-30-1. EU MEPS has an important role to play in helping European industry to maintain and grow its competitiveness.

Markings and documentation



From January 1st 2015 the stage 2 requirements for EU MEPS allow IE2 motors to be used only when they are fed by a VSD. These motors (7,5-375kW) must be marked so that the compulsory need to be used with a drive becomes evident. ABB uses the following stickers for the marking.

Mounting arrangements

Foot-mounted motor

Code I / code II

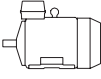
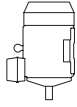
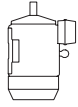
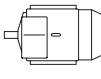
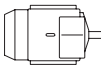
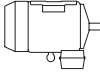
					
IM B3	IM V5	IM V6	IM B6	IM B7	IM B8
IM 1001	IM 1011	IM 1031	IM 1051	IM 1061	IM 1071

Product code pos. 12

A: foot-mounted, term. box top
 R: foot-mounted, term. box RHS
 L: foot-mounted, term. box LHS

Flange-mounted motor, large flange

Code I / code II

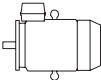
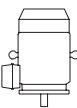
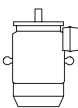
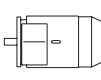
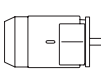
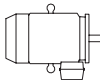
					
IM B5	IM V1	IM V3	*)	*)	*)
IM 3001	IM 3011	IM 3031	IM 3051	IM 3061	IM 3071

Product code pos. 12

B: flange mounted, large flange

Flange-mounted motor, small flange

Code I / code II

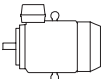
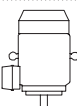
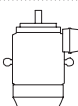
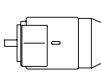
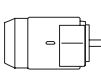
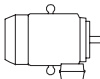
					
IM B14	IM V18	IM V19	*)	*)	*)
IM 3601	IM 3611	IM 3631	IM 3651	IM 3661	IM 3671

Product code pos. 12

C: flange mounted, small flange

Foot- and flange-mounted motor with feet, large flange

Code I / code II

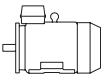
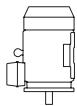
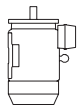
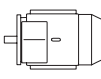
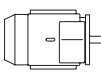
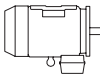
					
IM B35	IM V15	IM V35	*)	*)	*)
IM 2001	IM 2011	IM 2031	IM 2051	IM 2061	IM 2071

Product code pos. 12

H: foot/flange-mounted, term. box top
 S: foot/flange-mounted, term. box RHS
 T: foot/flange-mounted, term. box LHS

Foot- and flange-mounted motor with feet, small flange

Code I / code II

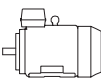
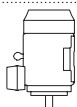
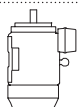
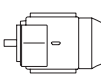
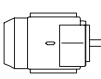
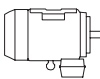
					
IM B34	IM V17	IM 2131	IM 2151	IM 2161	IM 2171
IM 2101	IM 2111	IM 2131	IM 2151	IM 2161	IM 2171

Product code pos. 12

J: foot/flange-mounted, small flange

Foot-mounted motor, shaft with free extensions

Code I / code II

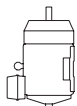
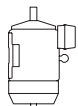
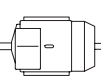
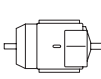
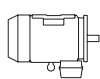
					
IM 1002	IM 1012	IM 1032	IM 1052	IM 1062	IM 1072

Product code pos. 12

*) Not stated in IEC 60034-7.

Note: If the motor is mounted shaft upwards, take measures to prevent water or any other liquid from running down the shaft into the motor.

General information

Cooling

Designation system concerning methods of cooling refers to standard IEC 60034-6.

Explanation of the product code

International Cooling	Circuit arrangement	Primary coolant	Method of movement of primary coolant	Secondary coolant	Method of movement of secondary coolant
IC	4	(A)	1	(A)	6
	1	2	3	4	5

Position 1

0:	Free circulation (open circuit)
4:	Free circulation (open circuit)

Position 2

A:	For air (omitted for simplified designation)
----	--

Position 3

0:	Free convection
1:	Self-circulation
6:	Machine-mounted independent component

Position 4

A:	For air (omitted for simplified designation)
W:	For water

Position 5

0:	Free convection
1:	Self-circulation
6:	Machine-mounted independent component
8:	Relative displacement

General information

Degrees of protection: IP code/IK code

Classification of degrees of protection provided by enclosures of rotating machines refers to:

- Standard IEC 60034-5 or EN 60529 for IP code
- Standard EN 50102 for IK code

IP protection

Protection of persons against getting in contact with (or approaching) live parts and against contact with moving parts inside the enclosure. Also protection of the machine against ingress of solid foreign objects. Protection of machines against the harmful effects due to the ingress of water.

Explanation of the IP code

Ingress protection	Degree of protection to persons and to parts of the motors inside the enclosure	Degree of protection provided by the enclosure with respect to harmful effects due to ingress of water
IP	5	5
	1	2

Position 1

2:	Motors protected against solid objects greater than 12 mm
4:	Motors protected against solid objects greater than 1 mm
5:	Dust-protected motors
6:	Dust-tight motors

Position 2

3:	Motors protected against spraying water
4:	Motors protected against splashing water
5:	Motors protected against water jets
6:	Motors protected against heavy seas

IK code

Classification of degrees of protection provided by enclosure for motors against external mechanical impacts.

Explanation of the IK code

International mechanical protection	Characteristic group
IK	08
	1

Position 1

Relation between IK code and impact energy:

IK code	Impact energy/Joule
0:	Not protected according to EN 50102
01:	0.15
02:	0.2
03:	0.35
04:	0.5
05:	0.7
06:	1
07:	2
08:	5 (ABB Standard)
09:	10
10:	20

General information

Insulation

ABB uses class F insulation, which, with temperature rise B, is the most common requirement among industry today.

The use of class F insulation with class B temperature rise gives ABB products a 25 °C safety margin. This can be used to increase the loading for limited periods, to operate at higher ambient temperatures or altitudes, or with greater voltage and frequency tolerances. It can also be used to extend insulation life. For instance, a 10 K temperature reduction will extend the insulation life.

Thermal class 130 (B)

- Nominal ambient temperature 40 °C
- Max permissible temperature rise 80 K
- Hot spot temperature margin 10 K

Thermal class 155 (F)

- Nominal ambient temperature 40 °C
- Max permissible temperature rise 105 K
- Hot spot temperature margin 10 K

Thermal class 180 (H)

- Nominal ambient temperature 40 °C
- Max permissible temperature rise 125 K
- Hot spot temperature margin 10 K

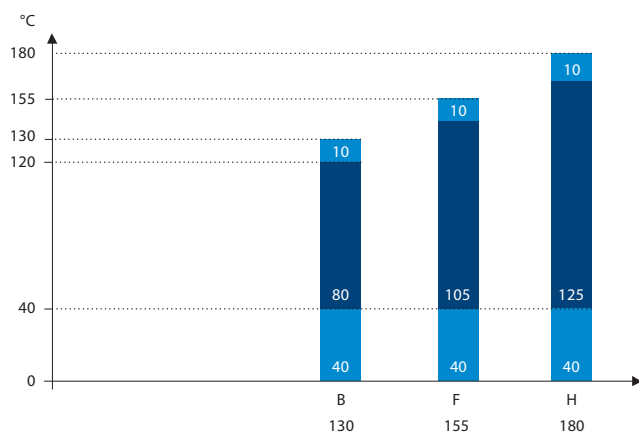

Safety margins per thermal class

General information

Voltage and frequency

The impact on temperature rise caused by voltage and frequency fluctuation is defined in IEC 60034-1. The standard divides the combinations into two zones, A and B. Zone A is the combination of voltage deviation of +/-5 % and frequency deviation of +/-2 %. Zone B is the combination of voltage deviation of +/-10 % and frequency deviation of +/-3%. This is illustrated in figure below.

Motors are capable of supplying the rated torque in both zones A and B, but the temperature rise will be higher than at rated voltage and frequency. Motors can be run in zone B only for a short period of time.

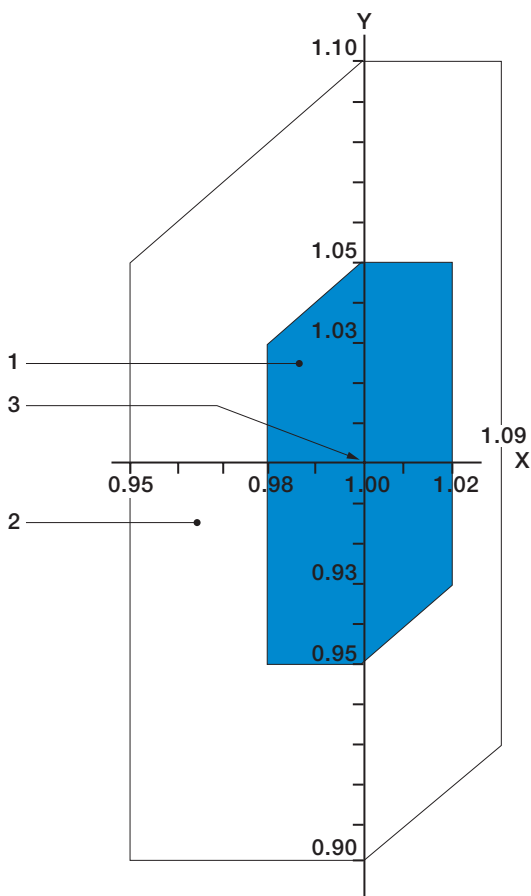

Figure Voltage and frequency deviation in zones A and B.

Key	
X axis	frequency p.u.
Y axis	voltage p.u.
1	zone A
2	zone B (outside zone A)
3	rating point

IE3 and IE2 General performance cast iron motors

Sizes 71 to 355, 0.18 to 355 kW

Ordering information	14
Rating plates	15
Technical data IE3	16
3000 r/min motors.....	16
1500 r/min motors.....	17
1000 r/min motors.....	18
Technical data IE2	19
3000 r/min motors.....	19
1500 r/min motors.....	20
1000 r/min motors.....	21
Variant codes	22
Mechanical design	24
Bearings.....	24
Terminal box.....	29
Dimension drawings	30
Motors in brief	31
Motor sizes 71 - 112.....	31
Motors in brief	32
Motor sizes 132 - 250.....	32
Motor sizes 280-355.....	33

Ordering information

Explanation of the product code

Motor type	Motor size	Product code	Mounting arrangement code, Voltage and frequency code, Generation code	Variant codes
M2BAX	112MA	3GBA 112 310	- ADD	002, etc.
		1 2 3 4 5 6 7 8 9 10 11 12 13 14		

When placing an order, specify motor type, size and product code according to the following example.

Example

Motor type	M2BAX 112 MA
Pole number	4
Mounting arrangement (IM-code)	IM B3 (IM 1001)
Rated output	4 kW
Product code	3GBA 112 310-ADD
Variant codes if needed	

Positions 1 to 4

3GBA: Totally enclosed fan cooled squirrel cage motor with cast iron frame

Positions 5 and 6

IEC size	
13:	132
16:	160
18:	180
20:	200
22:	225
25:	250
28:	280
31:	315
35:	355

Position 7

Speed (Pole pairs)	
1:	2 poles
2:	4 poles
3:	6 poles

Positions 8 to 10

Running number

Position 11

-(dash)

Position 12 (marked with black dot in data tables)

Mounting arrangement	
A:	Foot-mounted, top-mounted terminal box
B:	Flange-mounted, large flange

Position 13 (marked with black dot in data tables)

Voltage and frequency	
Single-speed motors	
D:	400 VΔ, 690 VY, 380 VΔ, 660 VY, 50 Hz 440 VΔ, 460 VΔ, 60 Hz
S:	230 VΔ, 400 VY, 220 VΔ, 380 VY, 50 Hz 440 VY, 460 VΔ 60 Hz*

*) M2AA 200 is not available for voltages less than 380 VD

Position 14

A, B, C... = Generation code followed by variant codes



Efficiency values are given according to IEC 60034-2-1; 2014

For detailed dimension drawings please see our web-pages 'www.abb.com/motors&generators' or contact ABB.



Rating plates

The motor's main rating plate shows the motor's performance values with various connections at nominal speed. The rating plate also shows the efficiency level (IE2, IE3), year of manufacture, and the lowest nominal efficiency at 100, 75, and 50 % nominal load.

The lubrication plate specifies regreasing amount, regreasing interval in hours - depending on the mounting position and ambient temperature - and types of lubricant recommended.

							
		IE2		<small>IEC60034-1</small>			
3- Motor		M2BAX 160MLA 4 IMB3/IM1001				2015	
3030389-1							
No. 3G1P194700429				Ins. cl. F IP 55			
V	Hz	kW	r/min	A	cos φ	Duty	
690	Y	50	11	14.77	13.0	0.79	S1
400	D	50	11	14.77	22.4	0.79	S1
660	Y	50	11	14.74	13.2	0.82	S1
380	D	50	11	14.74	22.7	0.82	S1
440	D	60	11	17.78	18.7	0.81	S1
460	D	60	11	17.77	19.1	0.83	S1
IE2-50Hz-89.8%(100%)-89.9%(75%)-89.2%(50%) / IE2-60Hz-91.0%(100%)							
Product code 3GBA162410-ADC							
6209-2Z/C3 				6209-2Z/C3			
						134 kg	

Rating plate for IE2 General performance cast iron M2BAX motor

							
		IE3		<small>IEC60034-1</small>			
3- Motor		M2BAX 280SMC 4 IMB3/IM1001				2014	
3026614-1							
No. 3G1P144001206				Ins. cl. F IP 55			
V	Hz	kW	r/min	A	cos φ	Duty	
690	Y	50	90	14.85	92	0.86	S1
400	D	50	90	14.85	159	0.86	S1
660	Y	50	90	14.83	96	0.87	S1
380	D	50	90	14.83	166	0.87	S1
440	D	60	90	17.85	144	0.86	S1
460	D	60	90	17.86	139	0.85	S1
IE3-50Hz-95.2(100%)-95.6(75%)-95.5(50%) / IE3-60Hz-95.4(100%)							
Product code 3GBA282230-ADM							
6217/C3 				6217/C3			
						621 kg	

Rating plate for IE3 General performance cast iron M2BAX motor

Technical data

IE3 General performance cast iron motors, 3000 r/min

IP 55 - IC 411 - Insulation class F, temperature rise class B
IE3 efficiency class according to IEC 60034-30-1; 2014

Output kW	Motor type	Product code	Speed r/min	Efficiency IEC 60034-30-1; 2014			Power factor Cosφ	Current Torque					Moment of inertia J = 1/4 GD ² kgm ²	Weight kg	Sound pressure Level L _{PA} dB
				Full load 100%	3/4 load 75%	1/2 load 50%		I _N A	I _s /I _N	T _N Nm	I _s /I _N	T _s /T _N			
3000 r/min = 2 poles				400 V 50 Hz				GENELEC-design							
0.37	M2BAX 71 MC	3GBA071330-••D	2819	76,5	76,0	73,4	0,80	0,86	6,6	1,3	2,7	3,2	0,000350	9	50
0.55	M2BAX 71 MB	3GBA071320-••D	2816	78,4	78,1	75,9	0,80	1,27	6,1	1,9	2,7	3,2	0,00040	10	49
0.75	M2BAX 80 MC	3GBA081330-••D	2891	80,7	81,0	78,9	0,80	1,66	7,5	2,5	2,9	3,7	0,000810	15	58
1.1	M2BAX 80 MD	3GBA081340-••D	2860	82,7	83,3	82,6	0,84	2,29	7,6	3,7	3,2	3,6	0,00102	17	60
1.5	M2BAX 90 SB	3GBA091120-••D	2912	84,2	84,0	82,5	0,83	3,04	8,0	5,0	2,8	3,9	0,00234	22	54
2.2	M2BAX 90 SLA	3GBA091010-••D	2908	85,9	85,6	83,9	0,81	4,54	8,2	7,3	3,2	3,9	0,00300	25	67
3	M2BAX 100 LKA	3GBA101810-••D	2910	87,1	88,0	88,0	0,91	5,38	8,3	9,8	3,0	3,8	0,00691	47	60
4	M2BAX 112 MB	3GBA111320-••D	2904	88,1	89,0	89,2	0,90	7,23	8,5	13,2	2,8	3,7	0,00711	46	64
5.5	M2BAX 132SMA 2	3GBA131210-••D	2934	89,2	89,8	89	0,82	10,6	8,9	17,9	2,4	4,1	0,0136	66	65
7.5	M2BAX 132SME 2	3GBA131250-••D	2901	90,1	91,1	91,2	0,91	13,1	7,3	24,7	2,2	3,7	0,0200	83	71
11	M2BAX 160MLA 2	3GBA161410-••D	2943	91,2	92,0	91,6	0,91	19,1	7,2	35,6	2,6	3,6	0,0570	118	69
15	M2BAX 160MLB 2	3GBA161420-••D	2947	91,9	92,2	91,8	0,88	26,5	8,2	48,5	3,2	4,2	0,0630	126	69
18.5	M2BAX 160MLC 2	3GBA161430-••D	2949	92,4	93,0	92,6	0,90	32,0	9,0	59,8	3,3	3,9	0,0760	144	73
22	M2BAX 180MLA 2	3GBA181410-••D	2956	92,7	93,1	92,7	0,90	37,7	7,8	71,0	3,4	3,8	0,1110	181	73
30	M2BAX 200MLA 2	3GBA201410-••D	2957	93,3	93,8	93,6	0,88	52,4	7,5	96,9	2,5	3,1	0,182	230	73
37	M2BAX 200MLB 2	3GBA201420-••D	2960	93,7	94,2	94,1	0,89	64,2	8,2	119,5	3,1	3,4	0,222	257	73
45	M2BAX 225SMA 2	3GBA221210-••D	2968	94,0	94,0	93,0	0,87	79,6	7,3	144,8	3,2	3,1	0,296	287	76
55	M2BAX 250SMA 2	3GBA251210-••D	2968	94,3	93,7	93,6	0,89	94,8	6,8	177,0	2,4	3,0	0,426	344	76
75	M2BAX 280SMB 2	3GBA281220-••M	2978	94,7	94,6	93,6	0,88	130	7,0	240,0	2,3	3,0	0,900	596	74
90	M2BAX 280SMC 2	3GBA281230-••M	2975	95,0	95,0	94,2	0,88	156	6,4	289,0	2,1	2,8	0,990	618	74
110	M2BAX 315SMB 2	3GBA311220-••M	2982	95,2	94,9	93,9	0,87	192	7,0	352,0	1,8	2,7	1,30	801	78
132	M2BAX 315SMC 2	3GBA311230-••M	2982	95,4	95,4	94,6	0,87	229	6,8	422,0	2,0	2,8	1,50	852	78
160	M2BAX 315SMD 2	3GBA311240-••M	2983	95,6	95,6	94,9	0,87	275	7,4	512,0	2,2	2,8	1,70	909	78
200	1) M2BAX 315MLA 2	3GBA311410-••M	2983	95,8	96,0	95,5	0,88	342	7,5	640,0	2,3	3,1	2,10	1051	81
250	M2BAX 355SMA 2	3GBA351210-••M	2985	95,8	95,6	94,6	0,89	423	7,7	800,0	2,1	3,3	3,00	1412	83
315	M2BAX 355SMB 2	3GBA351220-••M	2980	95,8	95,7	95,0	0,89	529	7,0	1009,0	2,1	3,0	3,40	1495	83
355	M2BAX 355SMC 2	3GBA351230-••M	2984	95,8	95,8	95,0	0,88	605	7,2	1136,0	2,2	3,0	3,60	1565	83

¹⁾ Temperature rise class F

Technical data

IE3 General performance cast iron motors, 1500 r/min

IP 55 - IC 411 - Insulation class F, temperature rise class B
IE3 efficiency class according to IEC 60034-30-1; 2014

Output kW	Motor type	Product code	Speed r/min	Efficiency IEC 60034-30-1; 2014			Power factor Cos ϕ	Current Torque					Moment of inertia J = 1/4 GD ² kgm ²	Weight kg	Sound pressure Level L _{PA} dB
				Full load 100%	3/4 load 75%	1/2 load 50%		I _N A	I _s /I _N	T _N Nm	I _s /I _N	T _s /T _N			
1500 r/min = 4 poles				400 V 50 Hz				GENELEC-design							
0.25	M2BAX 71 MB	3GBA072320-••D	1440	73,5	70,1	63,8	0,64	0,78	6,1	1,67	2,7	3,5	0,000750	11	41
0.37	M2BAX 71 MLA	3GBA072410-••D	1441	77,3	74,9	69,8	0,66	1,06	6,8	2,47	2,7	3,8	0,000980	13	50
0.55	M2BAX 80 MC	3GBA082330-••D	1446	80,8	80,7	78,0	0,74	1,32	8,0	3,64	2,7	3,9	0,00228	15	48
0.75	M2BAX 80 MLA	3GBA082410-••D	1445	82,5	81,2	77,6	0,70	1,84	7,8	4,88	3,8	4,6	0,00295	24	49
1.1	M2BAX 90 SB	3GBA092120-••D	1438	84,1	83,4	80,9	0,73	2,59	7,9	7,28	3,6	4,2	0,00394	22	48
1.5	M2BAX 90 SLA	3GBA092010-••D	1439	85,3	84,4	82,1	0,73	3,52	7,8	9,95	3,9	4,5	0,00485	24	44
2.2	M2BAX 100 LB	3GBA102520-••D	1450	86,7	86,1	84,1	0,78	4,74	8,4	14,5	3,4	4,4	0,00863	35	50
3	M2BAX 100 LKA	3GBA102810-••D	1448	87,7	87,7	86,5	0,79	6,25	8,6	19,9	3,6	4,5	0,0115	43	57
4	M2BAX 112 MLA	3GBA112410-••D	1443	88,6	88,9	88,1	0,81	8,11	8,5	26,5	3,6	4,4	0,0152	53	57
5.5	M2BAX 132SMA 4	3GBA132210-••D	1463	89,6	90,4	90,2	0,77	11,5	7,9	35,89	2,6	3,3	0,0297	68	68
7.5	M2BAX 132SME 4	3GBA132250-••D	1465	90,4	90,7	90,3	0,78	15,5	7,4	49,0	2,5	4,0	0,0370	77	60
11	M2BAX 160MLA 4	3GBA162410-••D	1477	91,4	91,8	91,1	0,82	21,1	7,6	71,3	2,6	3,3	0,110	134	61
15	M2BAX 160MLB 4	3GBA162420-••D	1477	92,1	92,4	91,6	0,82	28,5	8,2	97,0	3,0	3,7	0,135	159	61
18.5	M2BAX 180MLA 4	3GBA182410-••D	1481	92,6	93,2	92,9	0,83	34,9	7,2	119,3	2,8	3,0	0,219	192	60
22	M2BAX 180MLB 4	3GBA182420-••D	1481	93,0	93,5	93,3	0,82	41,4	6,5	142,0	3,0	3,2	0,243	205	60
30	M2BAX 200MLA 4	3GBA202410-••D	1483	93,6	93,8	93,4	0,84	54,8	7,5	193,2	2,7	3,2	0,385	259	63
37	M2BAX 225SMA 4	3GBA222210-••D	1482	93,9	94,1	93,8	0,83	68,9	7,2	238,6	3,1	3,1	0,427	274	67
45	M2BAX 225SMB 4	3GBA222220-••D	1482	94,2	94,4	94,0	0,84	82,3	8,0	290,0	3,2	3,5	0,525	307	66
55	M2BAX 250SMA 4	3GBA252210-••D	1482	94,6	94,7	94,0	0,84	100,0	7,1	354,2	2,9	3,4	0,694	358	68
75	M2BAX 280SMB 4	3GBA282220-••M	1485	95,0	95,2	94,8	0,86	133,0	6,4	483,0	2,3	2,8	1,380	573	75
90	M2BAX 280SMC 4	3GBA282230-••M	1485	95,2	95,3	94,8	0,86	159,0	7,1	588,0	2,5	2,9	1,730	636	75
110	M2BAX 315SMB 4	3GBA312220-••M	1489	95,4	95,4	94,8	0,85	196,0	7,0	705,0	2,1	3,0	2,430	823	71
132	M2BAX 315SMC 4	3GBA312230-••M	1488	95,6	95,8	95,3	0,86	231,0	6,7	847,0	2,2	2,9	2,90	892	71
160	M2BAX 315SMD 4	3GBA312240-••M	1488	95,8	96,0	95,8	0,85	282,0	6,9	1026,0	2,2	3,0	3,20	933	71
200	M2BAX 315MLB 4	3GBA312420-••M	1487	96,0	96,4	96,4	0,86	351,0	6,8	1284,0	2,4	3,0	3,90	1091	74
250	M2BAX 355SMA 4	3GBA352210-••M	1491	96,0	96,0	95,6	0,86	435,0	6,4	1601,0	2,1	2,9	5,90	1445	78
315	M2BAX 355SMB 4	3GBA352220-••M	1491	96,0	96,0	95,6	0,86	545,0	6,7	2018,0	2,3	3,0	6,90	1595	78
355	M2BAX 355SMC 4	3GBA352230-••M	1490	96,0	96,2	95,8	0,86	616,0	6,3	2273,0	2,3	2,8	7,20	1635	78

¹⁾Temperature rise class F

Technical data

IE3 General performance cast iron motors, 1000 r/min

IP 55 - IC 411 - Insulation class F, temperature rise class B
IE3 efficiency class according to IEC 60034-30-1; 2014

Output kW	Motor type	Product code	Speed r/min	Efficiency IEC 60034-30-1; 2014			Power factor Cosφ	Current Torque					Moment of inertia J = 1/4 GD ² kgm ²	Weight kg	Sound pressure Level L _{PA} dB
				Full load 100%	3/4 load 75%	1/2 load 50%		I _N A	I _s /I _N	T _N Nm	I _s /I _N	T _s /T _N			
1000 r/min = 6 poles				400 V 50 Hz				GENELEC-design							
0.18	M2BAX 71 MB	3GBA073320-••D	931	63,9	60,0	53,2	0,69	0,60	3,8	1,87	2,1	2,6	0,00103	10	39
0.25	M2BAX 71 MLA	3GBA073410-••D	926	68,6	66,3	60,9	0,67	0,80	4,3	2,58	2,6	2,9	0,00140	13	46
0.37	M2BAX 80 MC	3GBA083330-••D	939	73,5	71,5	66,7	0,66	1,09	5,6	3,80	2,8	3,2	0,00240	15	42
0.55	M2BAX 80 MLA	3GBA083410-••D	943	77,2	75,9	71,9	0,68	1,54	6,3	5,60	3,4	3,5	0,00353	20	48
0.75	M2BAX 90 SLA	3GBA093010-••D	952	78,9	78,0	73,9	0,59	2,35	5,3	7,52	3,1	3,6	0,00440	22	50
1.1	M2BAX 90 LB	3GBA093520-••D	954	81,0	80,3	75,5	0,62	3,20	6,1	11,1	3,3	3,9	0,00643	30	53
1.5	M2BAX 100 LKA	3GBA103810-••D	953	82,5	83,4	82,0	0,88	3,0	5,9	15,0	2,4	3,0	0,00975	38	59
2.2	M2BAX 112 MLA	3GBA113410-••D	957	84,3	83,8	81,5	0,64	5,94	6,5	22,0	2,9	3,7	0,0130	47	50
3	M2BAX 132 SMA	3GBA133210-••D	968	85,6	86,1	84,9	0,68	7,40	6,7	29,6	2,1	3,2	0,0291	66	48
4	M2BAX 132 SMB	3GBA133220-••D	972	86,8	86,8	84,9	0,65	10,1	7,0	39,3	2,7	3,6	0,0343	73	52
5.5	M2BAX 132 MLA	3GBA133410-••D	974	88,0	87,4	86,0	0,67	13,5	7,3	54,2	2,9	3,5	0,0510	103	65
7.5	M2BAX 160MLA 6	3GBA163410-••D	975	89,1	90,0	90,0	0,77	15,7	5,7	73,2	1,4	3,0	0,0890	119	59
11	M2BAX 160MLB 6	3GBA163420-••D	975	90,3	91,1	91,1	0,78	22,5	6,4	107,5	1,6	3,1	0,138	160	64
15	M2BAX 180MLA 6	3GBA183410-••D	979	91,2	91,9	91,6	0,79	30,1	5,2	146,9	1,5	2,7	0,212	190	63
18.5	M2BAX 200MLA 6	3GBA203410-••D	989	91,7	91,9	91,2	0,82	35,2	6,5	178,8	2,2	3,2	0,496	238	59
22	M2BAX 200MLB 6	3GBA203420-••D	989	92,2	92,4	91,4	0,81	42,4	7,3	212,4	2,6	3,5	0,585	263	59
30	M2BAX 225SMA 6	3GBA223210-••D	988	92,9	93,0	92,2	0,77	60,4	7,7	290,6	2,9	3,6	0,724	298	63
37	M2BAX 250SMA 6	3GBA253210-••D	990	93,3	93,7	93,5	0,80	71,1	6,5	357,0	2,4	3,1	1,30	379	58
45	M2BAX 280SMB 6	3GBA283220-••M	991	93,7	94,0	93,5	0,84	81,9	7,4	433,0	2,7	3,0	1,870	562	72
55	M2BAX 280SMC 6	3GBA283230-••M	993	94,1	94,3	93,8	0,86	98,2	7,5	530,0	2,8	3,0	2,570	615	71
75	M2BAX 315SMB 6	3GBA313220-••M	994	94,6	94,9	94,6	0,84	136,0	6,8	720,0	1,8	2,6	4,10	791	75
90	M2BAX 315SMC 6	3GBA313230-••M	994	94,9	95,1	94,7	0,84	164,0	7,2	864,0	2,0	3,0	4,60	859	76
110	M2BAX 315SMD 6	3GBA313240-••M	994	95,1	95,3	95,0	0,83	200,0	7,3	1056,0	2,2	3,1	4,90	912	75
132	M2BAX 315MLB 6	3GBA313420-••M	995	95,4	95,5	95,1	0,82	242,0	7,3	1266,0	2,3	3,2	6,30	1068	72
160	M2BAX 355SMA 6	3GBA353210-••M	993	95,6	95,9	95,6	0,82	292,0	6,7	1538,0	2,5	2,6	7,90	1348	75
200	M2BAX 355SMB 6	3GBA353220-••M	993	95,8	96,2	96,1	0,82	365,0	6,7	1923,0	2,6	2,5	9,70	1512	75
250	M2BAX 355SMC 6	3GBA353230-••M	993	95,8	96,1	95,8	0,81	464,0	7,7	2404,0	3,0	3,1	11,30	1656	75

Technical data

IE2 General performance cast iron motors, 3000 r/min

IP 55 - IC 411 - Insulation class F, temperature rise class B
IE2 efficiency class according to IEC 60034-30-1; 2014

Output kW	Motor type	Product code	Speed r/min	Efficiency IEC 60034-30-1; 2014			Power factor Cos ϕ_p	Current Torque					Moment of inertia J = 1/4 GD ² kgm ²	Weight kg	Sound pressure Level L _{PA} dB
				Full load 100%	3/4 load 75%	1/2 load 50%		I _N A	I _s /I _N	T _N Nm	T _r /T _N	T _b /T _N			
3000 r/min = 2 poles				400 V 50 Hz				GENELEC-design							
0.37	M2BAX 71MA 2	3GBA071310-••C	2807	73,5	72,8	68,7	0,80	0,9	5,1	1,3	2,6	3,5	0,000330	9	56
0.55	M2BAX 71MB 2	3GBA071320-••C	2820	75,5	75,5	72,2	0,79	1,3	5,2	1,9	2,7	3,5	0,000410	10	58
0.75	M2BAX 80MA 2	3GBA081310-••C	2830	77,4	77,8	75,3	0,83	1,7	5,4	2,5	2,9	4,3	0,000670	13	63
1.1	M2BAX 80MB 2	3GBA081320-••C	2849	79,6	80,4	78,7	0,84	2,4	5,4	3,7	2,9	4,1	0,000880	14	62
1.5	M2BAX 90SA 2	3GBA091110-••C	2890	81,3	81,0	78,2	0,80	3,3	6,5	4,9	2,5	3,8	0,00208	20	66
2.2	M2BAX 90LA 2	3GBA091510-••C	2897	83,2	83,6	81,7	0,85	4,5	7,5	7,3	2,5	3,8	0,00274	23	67
3	M2BAX 100LA 2	3GBA101510-••C	2919	84,6	84,0	81,3	0,85	6,0	8,5	9,8	3,4	5,0	0,00475	32	74
4	M2BAX 112MA 2	3GBA111310-••C	2916	85,8	85,3	83,1	0,87	7,7	9,1	13,1	4,1	4,7	0,00561	36	75
5.5	M2BAX 132SA 2	3GBA131110-••C	2921	87,0	85,9	83,6	0,86	10,6	8,3	18,0	2,6	4,3	0,0117	54	74
7.5	M2BAX 132SB 2	3GBA131120-••C	2916	88,1	87,5	85,8	0,85	14,5	8,7	24,6	3,1	4,5	0,0132	58	73
11	M2BAX 160MLA 2	3GBA161410-••C	2931	89,4	89,4	88,4	0,86	20,7	6,6	35,9	2,5	3,5	0,0413	102	72
15	M2BAX 160MLB 2	3GBA161420-••C	2938	90,3	90,6	89,8	0,89	26,9	7,6	48,9	3,0	3,5	0,0538	115	72
18.5	M2BAX 160MLC 2	3GBA161430-••C	2939	90,9	91,0	90,3	0,88	33,4	7,9	60,1	3,1	3,8	0,060	123	73
22	M2BAX 180MLA 2	3GBA181410-••C	2943	91,3	91,4	90,7	0,88	39,5	8,4	71,4	3,8	3,9	0,0735	150	72
30	M2BAX 200MLA 2	3GBA201410-••C	2957	92,0	91,5	90,1	0,85	55,4	8,6	97,1	4,0	4,2	0,110	198	81
37	M2BAX 200MLB 2	3GBA201420-••C	2951	92,5	92,5	92,1	0,90	64,2	8,4	120	3,6	3,7	0,141	229	80
45	M2BAX 225SMA 2	3GBA221210-••C	2962	92,9	92,8	92,1	0,87	80,4	8,8	145	3,8	3,8	0,226	273	82
55	M2BAX 250SMA 2	3GBA251210-••C	2965	93,2	93,2	92,6	0,88	96,8	7,4	177	3,4	3,0	0,344	334	78
75	M2BAX 280SA 2	3GBA281110-••C	2977	94,0	93,7	92,3	0,88	130	7,6	240	2,1	3,0	0,80	530	78
90	M2BAX 280SMB 2	3GBA281220-••C	2976	94,3	94,2	93,1	0,90	153	7,4	288	2,1	2,9	0,90	570	78
110	M2BAX 315SMA 2	3GBA311210-••C	2982	94,6	94,1	92,7	0,86	195	7,6	352	2,0	3,0	1,20	750	78
132	M2BAX 315SMB 2	3GBA311220-••C	2982	94,9	94,6	93,4	0,88	228	7,4	422	2,2	3,0	1,40	810	78
160	M2BAX 315SMC 2	3GBA311230-••C	2981	95,2	95,0	94,1	0,89	272	7,5	512	2,3	3,0	1,70	900	78
200	M2BAX 315MLA 2	3GBA311410-••C	2980	95,3	95,2	94,4	0,90	336	7,7	640	2,6	3,0	2,10	1020	83
250	M2BAX 355SMA 2	3GBA351210-••C	2983	95,4	95,2	94,3	0,89	424	6,8	800	1,5	2,8	2,70	1310	83
315	M2BAX 355SMB 2	3GBA351220-••C	2980	95,4	95,4	94,7	0,89	535	7,2	1009	1,9	2,8	3,40	1450	83
355	M2BAX 355SMC 2	3GBA351230-••C	2983	95,5	95,5	94,9	0,88	609	7,4	1136	2,1	2,7	3,60	1520	83

Note! Please check the availability for sizes 280-355 with ABB

Technical data

IE2 General performance cast iron motors, 1500 r/min

IP 55 - IC 411 - Insulation class F, temperature rise class B
IE2 efficiency class according to IEC 60034-30-1; 2014

Output kW	Motor type	Product code	Speed r/min	Efficiency IEC 60034-30-1; 2014			Power factor Cosφ	Current Torque					Moment of inertia J = 1/4 GD ² kgm ²	Weight kg	Sound pressure Level L _{PA} dB
				Full load 100%	3/4 load 75%	1/2 load 50%		I _N A	I _s /I _N	T _N Nm	T _f /T _N	T _b /T _N			
1500 r/min = 4 poles				400 V 50 Hz				GENELEC-design							
0.25	M2BAX 71MA 4	3GBA072310-••C	1415	67,0	63,1	56,6	0,73	0,74	4,4	1,68	2,1	2,8	0,000590	9	49
0.37	M2BAX 71MB 4	3GBA072320-••C	1407	69,5	69,0	64,4	0,77	1,0	4,2	2,5	1,9	2,7	0,000590	10	49
0.55	M2BAX 80MA 4	3GBA082310-••C	1413	73,5	73,2	69,2	0,76	1,4	4,7	3,7	2,0	2,9	0,00156	13	54
0.75	M2BAX 80MB 4	3GBA082320-••C	1462	79,6	78,5	74,4	0,71	1,9	6,2	5,0	3,1	3,9	0,00247	17	53
1.1	M2BAX 90SA 4	3GBA092110-••C	1447	81,4	80,7	77,2	0,73	2,7	6,3	7,4	3,2	4,3	0,00372	21	51
1.5	M2BAX 90LA 4	3GBA092510-••C	1441	82,8	82,6	79,8	0,74	3,5	6,6	10,0	3,1	4,2	0,00462	23	55
2.2	M2BAX 100LA 4	3GBA102510-••C	1445	84,3	84,2	81,9	0,78	4,8	6,7	14,5	2,6	3,8	0,00759	31	55
3	M2BAX 100LB 4	3GBA102520-••C	1443	85,5	85,4	83,3	0,79	6,4	7,4	19,8	2,8	4,2	0,00939	35	58
4	M2BAX 112MA 4	3GBA112310-••C	1442	86,6	86,2	84,6	0,79	8,4	7,5	26,5	4,0	4,3	0,0120	41	57
5.5	M2BAX 132SA 4	3GBA132110-••C	1457	87,7	87,5	86,2	0,78	11,6	6,9	36,0	2,5	3,4	0,0257	57	66
7.5	M2BAX 132MA 4	3GBA132310-••C	1457	88,7	88,6	87,5	0,78	15,6	7,2	49,1	2,6	3,6	0,0320	68	67
11	M2BAX 160MLA 4	3GBA162410-••C	1466	89,8	89,9	89,2	0,79	22,4	7,0	71,5	3,2	3,2	0,0784	110	67
15	M2BAX 160MLB 4	3GBA162420-••C	1468	90,6	91,1	90,5	0,82	29,1	8,0	97,7	3,2	3,7	0,10	125	66
18.5	M2BAX 180MLA 4	3GBA182410-••C	1470	91,2	91,5	90,6	0,80	36,6	8,5	120	3,7	4,2	0,120	155	65
22	M2BAX 180MLB 4	3GBA182420-••C	1472	91,6	91,3	90,2	0,78	44,4	9,2	143	4,1	4,6	0,139	168	66
30	M2BAX 200MLA 4	3GBA202410-••C	1476	92,3	92,4	92,0	0,81	57,9	6,8	194	3,0	3,2	0,236	222	68
37	M2BAX 225SMA 4	3GBA222210-••C	1479	92,7	92,7	92,2	0,82	70,3	7,4	239	3,1	3,3	0,350	263	69
45	M2BAX 225SMB 4	3GBA222220-••C	1481	93,1	93,0	92,3	0,81	86,1	7,9	290	3,5	3,5	0,416	290	69
55	M2BAX 250SMA 4	3GBA252210-••C	1480	93,5	93,4	92,7	0,83	102	7,6	355	3,3	3,3	0,533	339	77
75	M2BAX 280SA 4	3GBA282110-••C	1484	94,2	94,2	93,5	0,85	135	6,9	482	2,5	2,8	1,250	515	71
90	M2BAX 280SMB 4	3GBA282220-••C	1483	94,4	94,6	94,1	0,86	160	7,2	579	2,5	2,7	1,50	575	71
110	M2BAX 315SMA 4	3GBA312210-••C	1487	94,7	94,6	93,8	0,86	194	7,2	706	2,0	2,5	2,30	775	78
132	M2BAX 315SMB 4	3GBA312220-••C	1487	95,0	95,0	94,3	0,86	233	7,1	847	2,3	2,7	2,60	830	78
160	M2BAX 315SMC 4	3GBA312230-••C	1487	95,2	95,3	94,6	0,85	285	7,2	1027	2,4	2,9	2,90	870	78
200	M2BAX 315MLA 4	3GBA312410-••C	1486	95,3	95,4	94,9	0,86	352	7,0	1285	2,3	2,8	3,50	995	78
250	M2BAX 355SMA 4	3GBA352210-••C	1488	95,2	95,2	94,4	0,85	445	6,7	1604	2,0	2,6	5,40	1400	82
315	M2BAX 355SMB 4	3GBA352220-••C	1488	95,5	95,5	94,8	0,85	560	7,3	2021	2,2	2,7	6,90	1570	82
355	M2BAX 355SMC 4	3GBA352230-••C	1487	95,5	95,7	95,2	0,86	623	6,8	2279	2,4	2,7	7,20	1650	82

Note! Please check the availability for sizes 280-355 with ABB

Technical data

IE2 General performance cast iron motors, 1000 r/min

IP 55 - IC 411 - Insulation class F, temperature rise class B
IE2 efficiency class according to IEC 60034-30-1; 2014

Output kW	Motor type	Product code	Speed r/min	Efficiency IEC 60034-30-1; 2014			Power factor Cos ϕ	Current Torque					Moment of inertia J = 1/4 GD ² kgm ²	Weight kg	Sound pressure Level L _{PA} dB
				Full load 100%	3/4 load 75%	1/2 load 50%		I _N A	I _s /I _N	T _N Nm	T _r /T _N	T _v /T _N			
1000 r/min = 6 poles				400 V 50 Hz				GENELEC-design							
0.18	M2BAX 71MA 6	3GBA073310-••C	910	59,0	54,7	47,5	0,72	0,61	3,3	1,87	2,0	2,4	0,000820	9	40
0.25	M2BAX 71MB 6	3GBA073320-••C	913	63,0	59,9	53,8	0,71	0,81	3,6	2,64	2,4	2,8	0,00105	10	46
0.37	M2BAX 80MA 6	3GBA083310-••C	919	68,0	66,6	60,8	0,74	1,1	3,9	3,8	2,4	2,9	0,00173	13	49
0.55	M2BAX 80MB 6	3GBA083320-••C	921	71,0	69,8	64,7	0,73	1,5	4,2	5,7	2,6	3,0	0,00234	14	47
0.75	M2BAX 90SA 6	3GBA093110-••C	949	75,9	74,3	69,2	0,62	2,3	4,5	7,6	3,2	3,7	0,00438	21	50
1.1	M2BAX 90LA 6	3GBA093510-••C	936	78,1	78,0	74,7	0,67	3,0	4,5	11,1	2,5	3,3	0,00507	24	48
1.5	M2BAX 100LA 6	3GBA103510-••C	953	79,8	79,4	76,0	0,67	4,1	4,9	15,0	2,1	3,1	0,00795	31	56
2.2	M2BAX 112MA 6	3GBA113310-••C	956	81,8	81,4	78,4	0,68	5,7	5,3	21,9	2,3	3,5	0,0116	40	54
3	M2BAX 132SA 6	3GBA133110-••C	967	83,3	82,8	79,8	0,65	8,0	5,0	29,5	1,7	3,0	0,0251	55	60
4	M2BAX 132MA 6	3GBA133310-••C	965	84,6	84,2	82,4	0,70	9,8	5,7	40,0	2,6	3,3	0,0294	63	58
5.5	M2BAX 132MB 6	3GBA133320-••C	964	86,0	85,9	84,7	0,68	13,6	5,8	54,2	2,2	2,9	0,0397	77	62
7.5	M2BAX 160MLA 6	3GBA163410-••C	974	87,2	87,5	86,9	0,76	16,3	6,6	73,7	2,0	3,2	0,0811	113	65
11	M2BAX 160MLB 6	3GBA163420-••C	971	88,7	89,4	89,8	0,79	22,7	6,6	108	1,6	2,8	0,102	133	57
15	M2BAX 180MLA 6	3GBA183410-••C	971	89,7	90,0	89,6	0,77	31,3	7,4	147	2,4	3,9	0,136	168	62
18.5	M2BAX 200MLA 6	3GBA203410-••C	978	90,4	90,7	90,0	0,77	38,4	6,1	181	2,0	2,9	0,204	205	61
22	M2BAX 200MLB 6	3GBA203420-••C	978	90,9	91,1	90,5	0,78	44,8	6,2	215	1,8	2,9	0,227	219	62
30	M2BAX 225SMA 6	3GBA223210-••C	987	91,7	91,5	90,5	0,79	59,8	7,0	290	2,7	3,2	0,579	282	64
37	M2BAX 250SMA 6	3GBA253210-••C	986	92,2	92,5	91,9	0,81	71,5	6,9	359	2,6	2,9	0,783	336	66
45	M2BAX 280SA 6	3GBA283110-••C	990	92,8	93,0	92,1	0,84	83,3	7,0	434	2,5	2,5	1,850	500	71
55	M2BAX 280SB 6	3GBA283120-••C	990	93,3	93,5	92,9	0,84	101	7,0	530	2,7	2,6	2,20	540	71
75	M2BAX 315SMA 6	3GBA313210-••C	992	94,0	94,0	93,0	0,81	142	7,0	721	2,1	2,7	3,20	705	75
90	M2BAX 315SMB 6	3GBA313220-••C	992	94,3	94,4	93,6	0,83	165	7,2	866	2,1	2,7	4,10	800	75
110	M2BAX 315SMC 6	3GBA313230-••C	992	94,7	94,8	94,2	0,83	201	7,0	1058	2,2	2,7	4,90	870	75
132	M2BAX 315MLA 6	3GBA313410-••C	992	94,9	95,0	94,4	0,83	241	7,2	1270	2,4	2,7	5,80	980	75
160	M2BAX 355SMA 6	3GBA353210-••C	992	94,9	95,0	94,4	0,83	293	6,2	1540	2,1	2,3	7,30	1290	77
200	M2BAX 355SMB 6	3GBA353220-••C	992	95,2	95,4	94,9	0,84	360	6,5	1925	2,1	2,3	9,70	1440	77
250	M2BAX 355SMC 6	3GBA353230-••C	991	95,3	95,5	95,2	0,84	450	6,7	2409	2,3	2,3	11,30	1590	77

Note! Please check the availability for sizes 280-355 with ABB

Variant codes

IE3 and IE2 General performance cast iron motors

Variant codes specify additional options and features to the standard motor. The desired features are listed as three-digit variant codes in the motor order. Note also that there are variants that cannot be used together.

Code/Variants M2BAX	Frame size													
	71	80	90	100	112	132	160	180	200	225	250	280	315	355
Bearings and Lubrication														
037	Roller bearing at D-end.	-	-	-	-	-	•	•	•	•	•	•	•	•
041	Bearings regreasable via grease nipples.	-	-	-	-	-	•	•	•	•	•	○	○	○
043	SPM compatible nipples for vibration measurement	-	-	-	-	-	•	•	•	•	•	•	•	•
Branch standard designs														
178	Stainless steel / acid proof bolts.	•	•	•	•	•	•	•	•	•	•	•	•	•
Cooling system														
068	Light alloy metal fan	•	•	•	•	•	•	•	•	•	•	•	•	•
183	Separate motor cooling (fan axial, N-end).	•	•	•	•	•	•	•	•	•	•	•	•	-
Drain holes														
065	Plugged existing drain holes.	•	•	•	•	•	•	•	•	•	•	•	•	•
Earthing bolt														
067	External earthing bolt	○	○	○	○	○	○	○	○	○	○	○	○	○
Heating elements														
450	Heating element, 100-120 V	•	•	•	•	•	•	•	•	•	•	•	•	•
451	Heating element, 200 - 240 V	•	•	•	•	•	•	•	•	•	•	•	•	•
Marine														
096	Fulfilling Lloyds Register of Shipping (LR) requirements, without certificate (non-essential duty only)	•	•	•	•	•	•	•	•	•	•	•	•	•
186	Fulfilling Det Norske Veritas (DNV) requirements, without certificate (non-essential duty only)	•	•	•	•	•	•	•	•	•	•	•	•	•
496	Fulfilling Bureau Veritas (BV) requirements, without certificate(non-essential duty only)	•	•	•	•	•	•	•	•	•	•	•	•	•
675	Fulfilling American Bureau of Shipping (ABS) requirements, without certificate (non-essential duty only)	•	•	•	•	•	•	•	•	•	•	•	•	•
676	Fulfilling Germanischer Lloyd (GL) requirements, without certificate (non-essential duty only)	•	•	•	•	•	•	•	•	•	•	•	•	•
Mounting arrangements														
008	IM 2101 foot/flange mounted, IEC flange, from IM 1001 (B34 from B3).	•	•	•	•	•	•	-	-	-	-	-	-	-
009	IM 2001 foot/flange mounted, IEC flange, from IM 1001 (B35 from B3).	•	•	•	•	•	•	•	•	•	•	•	•	•
047	IM 3601 flange mounted, IEC flange, from IM 3001 (B14 from B5).	•	•	•	•	•	•	-	-	-	-	-	-	-
048	IM 3001 flange mounted, IEC flange, from IM 3601 (B5 from B14).	•	•	•	•	•	•	-	-	-	-	-	-	-
066	Modified for specified mounting position differing from IM B3 (1001), IM B5 (3001), B14 (3601), IM B35 (2001), IM B34 (2101)	•	•	•	•	•	•	•	•	•	•	•	•	•
Painting														
114	Special paint color, standard grade	•	•	•	•	•	•	•	•	•	•	•	•	•
Protection														
005	Protective roof, vertical motor, shaft down.	•	•	•	•	•	•	•	•	•	•	•	•	•
072	Radial seal at D-end. Not possible for 2-pole , 280 and 315 frames	•	•	•	•	•	•	•	•	•	•	•	•	•
158	Degree of protection IP65.	•	•	•	•	•	•	•	•	•	•	•	•	•
403	Degree of protection IP56.	•	•	•	•	•	•	•	•	•	•	•	•	•
784	Gamma-seal at D-end.	•	•	•	•	•	•	•	•	•	•	•	•	•
Rating & instruction plates														
002	Restamping voltage, frequency and output, continuous duty.	•	•	•	•	•	•	•	•	•	•	•	•	•
095	Restamping output (maintained voltage, frequency), intermittent duty.	•	•	•	•	•	•	•	•	•	•	•	•	•
098	Stainless steel rating plate	○	○	○	○	○	○	○	○	○	○	○	○	○
135	Mounting of additional identification plate, stainless.	•	•	•	•	•	•	•	•	•	•	•	•	•
159	Additional plate with text "Made in..."	•	•	•	•	•	•	•	•	•	•	•	•	•
161	Additional rating plate delivered loose.	•	•	•	•	•	•	•	•	•	•	•	•	•
163	Frequency converter rating plate. Rating data according to quotation.	•	•	•	•	•	•	•	•	•	•	•	•	•
181	Rating plate with ABB standard loadability values for VSD operation. Other auxiliaries for VSD operation to be selected as necessary.	-	-	-	-	-	•	•	•	•	•	•	•	•
Standards and Regulations														
331	IE1 motor not for sale for use in EU	•	•	•	•	•	•	•	•	•	•	•	•	•
540	China energy label	•	•	•	•	•	•	•	•	•	•	•	•	•
543	Australian MEPS	-	-	-	-	-	•	•	•	•	•	•	•	•

○ = Included as standard | • = Available as option | - = Not applicable

Code/Variants M2BAX	Frame size													
	71	80	90	100	112	132	160	180	200	225	250	280	315	355
822 WIMES 3.03i6 Compliant Design for DOL operation	-	-	-	-	-	•	•	•	•	•	•	•	•	•
Stator winding temperature sensors														
122 Bimetal detectors, break type (NCC), (3 in series), 150 °C, in stator winding	•	•	•	•	•	•	•	•	•	•	•	•	•	•
435 PTC - thermistors (3 in series), 130 °C, in stator winding	•	•	•	•	•	•	•	•	•	•	•	•	•	•
436 PTC - thermistors (3 in series), 150 °C, in stator winding	○	○	○	○	○	○	○	○	○	○	○	○	○	○
439 PTC - thermistors (2x3 in series), 150 °C, in stator winding	•	•	•	•	•	•	•	•	•	•	•	•	•	•
445 Pt100 2-wire in stator winding, 1 per phase	•	•	•	•	•	•	•	•	•	•	•	•	•	•
Terminal box														
022 Cable entry LHS (seen from D-end).	•	•	•	•	•	•	•	•	•	•	•	•	•	•
230 Standard metal cable gland.	•	•	•	•	•	•	•	•	•	•	•	•	•	•
375 Standard plastic cable gland	•	•	•	•	•	•	•	•	•	•	•	•	-	-
376 Two standard plastic cable glands	•	•	•	•	•	•	•	•	•	•	•	•	-	-
400 4 x 90 degr turnable terminal box.	•	•	•	•	•	•	○	○	○	○	○	○	○	○
418 Separate terminal box for auxiliaries, standard material.	•	•	•	•	•	•	•	•	•	•	•	•	-	-
447 Top mounted separate terminal box for monitoring equipment.	-	-	-	-	-	-	-	-	-	-	-	•	•	•
731 Two standard metal cable glands.	•	•	•	•	•	•	•	•	•	•	•	•	•	•
Testing														
145 Type test report from a catalogue motor, 400V 50Hz.	•	•	•	•	•	•	•	•	•	•	•	•	•	•
148 Routine test report.	•	•	•	•	•	•	•	•	•	•	•	•	•	•
Variable speed drives														
470 Prepared for hollow shaft pulse tacho (L&L equivalent).	-	-	-	-	-	-	•	•	•	•	•	•	•	•
472 1024 pulse tacho (L&L 861007455-1024).	-	-	-	-	-	-	•	•	•	•	•	•	•	•
473 2048 pulse tacho (L&L 861007455-2048).	-	-	-	-	-	-	•	•	•	•	•	•	•	•
701 Insulated bearing at N-end.	-	-	-	-	-	-	-	-	-	-	-	•	•	•
704 EMC cable entry.	•	•	•	•	•	•	•	•	•	•	•	•	•	•

○ = Included as standard | • = Available as option | - = Not applicable

Mechanical design

Bearings

General performance motors are normally fitted with single-row deep-groove ball bearings, as shown in the table below.

If the bearing at the D-end is replaced with a roller bearing (NU- or NJ-), higher radial forces can be handled. Roller bearings are suitable for belt-drive applications and can be ordered with variant code 037.

Standard and alternative designs

Motor size	Poles	Standard design		Alternative design
		Deep groove ball bearings		Deep groove ball bearings
		D-end	N-end	Roller bearings (VC037)
		D-end	N-end	D-end
71	2 - 6	6203-2Z/C3	6202-2Z/C3	
80	2 - 6	6204-2Z/C3	6203-2Z/C3	
90	2 - 6	6205-2Z/C3	6204-2Z/C3	
100	2 - 6	6206-2Z/C3	6205-2Z/C3	
112	2 - 6	6206-2Z/C3	6205-2Z/C3	
132	2 - 4	6208-2Z/C3	6208-2Z/C3	NU 208 ECP/C3
160	2 - 6	6209-2Z/C3	6209-2Z/C3	NU 209 ECP/C3
180	2 - 6	6210-2Z/C3	6209-2Z/C3	NU 210 ECP/C3
200	2 - 6	6212-2Z/C3	6209-2Z/C3	NU 212 ECP/C3
225	2 - 6	6213-2Z/C3	6210-2Z/C3	NU 213 ECP/C3
250	2 - 6	6215-2Z/C3	6212-2Z/C3	NU 215 ECP/C3
280	2 - 6	6217/C3	6217/C3	NU 217 ECP/C3
315	2	6217/C3	6217/C3	NU 217 ECP/C3
315	4 - 6	6219/C3	6217/C3	NU 219 ECP/C3
355	2	6219/C3	6219/C3	NU 219 ECP/C3
355	4 - 6	6222/C3	6219/C3	NU 222 ECP/C3

Axially-locked bearings

All motors are equipped as standard with an axially locked bearing at the D-end.

Mechanical design

Radial forces

Permissible loading on the shaft

The following table shows permissible radial forces on the shaft in Newtons, assuming zero axial force, a 25 °C ambient temperature, and normal conditions. The values are given for a calculated bearing life of 20 000 and 40 000 hours per motor size.

These calculated values further assume mounting position IM B3 (foot-mounted), with force directed sideways. In some cases, the strength of the shaft affects permissible forces.

Permissible loads of simultaneous radial and axial forces can be supplied on request.

If the radial force is applied between points X_0 and X_{\max} , the permissible force F_R can be calculated with the following formula:

$$F_R = F_{X_0} - \frac{X}{E} (F_{X_0} - F_{X_{\max}})$$

Where:

E: length of the shaft extension in the standard version

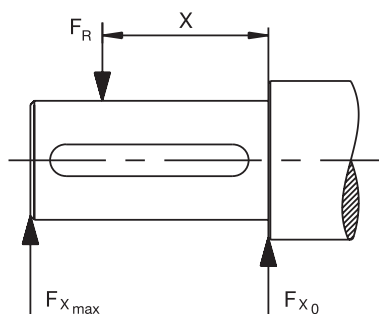

Permissible radial forces, M2BAX motor sizes 71-355, IE3 and IE2

Motor size	Poles	Length of shaft extension E (mm)	Basic design with deep groove ball bearings				Basic design with deep groove roller bearings			
			20,000 h		40,000 h		20,000 h		40,000 h	
			$F_{x0}(N)$	$F_{xmax}(N)$	$F_{x0}(N)$	$F_{xmax}(N)$	$F_{x0}(N)$	$F_{xmax}(N)$	$F_{x0}(N)$	$F_{xmax}(N)$
71	2	30	545	465	430	370				
	4	30	685	585	545	465				
	6	30	785	660	620	530				
80	2	40	740	620	585	490				
	4	40	925	775	730	615				
	6	40	1065	890	840	705				
90S	2	50	795	645	625	510				
	4	50	1000	815	790	645				
	6	50	1145	935	905	740				
90L	2	50	795	660	630	520				
	4	50	1005	830	790	655				
	6	50	1150	950	910	750				
100	2	60	1110	895	875	705				
	4	60	1395	1120	1100	885				
	6	60	1605	1290	1265	1020				
112	2	60	1120	925	885	730				
	4	60	1405	1160	1105	915				
	6	60	1615	1335	1275	1050				
132S	2	80	1630	1270	1285	1000				
	4	80	2055	1600	1620	1260				
	6	80	2360	1840	1860	1450				
132M	4	80	2075	1665	1630	1310				
	6	80	2375	1905	1865	1495				
	2	110	1945	1510	1545	1195				
160	4	110	2455	1905	1945	1510				
	6	110	2835	2250	2245	1780				
	2	110	2095	1705	1660	1350				
180	4	110	2640	2145	2090	1700				
	6	110	3025	2460	2395	1950				
	2	110	2800	2350	2200	1830				
200	4	110	3550	2910	2810	2305				
	6	110	4065	3335	3220	2640				
	2	110	3335	2795	2640	2215				
225	4	140	4200	3370	3325	2670				
	6	140	4810	3860	2805	3055				
	2	140	3965	3220	3140	2550				
250	4	140	4995	4060	3995	3215				
	6	140	5715	4645	4525	3675				
	2	140	4900	4050	3850	3200	14750	6850	12000	6850
280	4	140	6150	5100	4850	4050	18200	11200	14750	11200
	6	140	7050	5850	5550	4600	20550	11200	16650	11200
	2	140	4900	4150	3850	3250	14900	6650	12100	6650
315	4	170	8000	6650	6350	5250	21200	10350	17200	10350
	6	170	9150	7550	7200	5950	23900	10250	19400	10250
	2	140	6250	5500	4900	4300	17200	7850	13950	7850
355	4	210	10500	8700	8250	6800	28050	16250	22750	16250
	6	210	12000	9900	9400	7750	31650	16200	25700	16200

Mechanical design

Axial forces

The following tables present permissible axial forces on the shaft in Newtons, assuming zero radial force, a 25 °C ambient temperature, and normal conditions. The values are given for a calculated bearing life of 20,000 and 40,000 hours per motor size.

At 60 Hz, the values must be reduced by 10 percent, and for two-speed motors, the higher speed determines permissible axial force. Permissible loads of simultaneous radial and axial forces can be supplied on request.

For axial force F_{AD} , it is assumed that the D-bearing is locked with a locking ring.

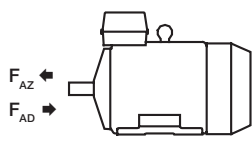

Mounting arrangement IM B3

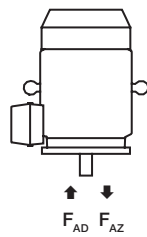

Mounting arrangement IM V1

Permissible axial forces, motor sizes 71-112, IE3 and IE2

Motor size	Poles	Length of shaft extension E (mm)	Mounting arrangement IM B3				Mounting arrangement IM V1			
			Deep groove ball bearings				Deep groove ball bearings			
			20,000 h		40,000 h		20,000 h		40,000 h	
F_{AD} (N)	F_{AZ} (N)	F_{AD} (N)	F_{AZ} (N)	F_{AD} (N)	F_{AZ} (N)	F_{AD} (N)	F_{AZ} (N)			
71	2	30	580	300	465	185				
	4	30	725	445	580	300				
	6	30	810	530	670	390				
80	2	40	750	430	595	275				
	4	40	940	620	750	430				
	6	40	1055	735	870	550				
90	2	50	845	445	675	275				
	4	50	1050	650	840	440				
	6	50	1175	775	935	535				
100	2	60	1175	615	940	380				
	4	60	1465	905	1175	615				
	6	60	1640	1080	1305	745				
112	2	60	1175	615	935	375				
	4	60	1460	900	1170	610				
	6	60	1635	1075	1300	740				

Permissible axial forces, motor sizes 132-355, IE3 and IE2

Motor size	Poles	Length of shaft extension E (mm)	Mounting arrangement IM B3				Mounting arrangement IM V1			
			Deep groove ball bearings				Deep groove ball bearings			
			20,000 h		40,000 h		20,000 h		40,000 h	
			$F_{AD}(N)$	$F_{AZ}(N)$	$F_{AD}(N)$	$F_{AZ}(N)$	$F_{AD}(N)$	$F_{AZ}(N)$	$F_{AD}(N)$	$F_{AZ}(N)$
132	2	80	1750	950	1400	600	1900	850	1550	500
	4	80	2200	1400	1750	950	2400	1250	1950	800
160	2	110	1750	1050	1400	700	2050	800	1700	400
	4	110	2200	1500	1700	1050	2650	1150	2200	650
	6	110	2550	1850	2000	1300	2950	1500	2400	950
180	2	110	1800	1100	1450	750	2300	800	1900	400
	4	110	2300	1600	1750	1100	2950	1100	2450	600
	6	110	2650	2000	2050	1400	3300	1550	2700	950
200	2	110	2300	1600	1800	1100	2950	1150	2400	650
	4	110	2950	2300	2300	1600	3850	1650	3200	1000
	6	110	3450	2750	2600	1950	4450	2000	3600	1200
225	2	110	2500	2100	1900	1500	3250	1600	2650	1000
	4	140	3250	2850	2450	2050	4150	2150	3350	1350
	6	140	3800	3400	2850	2500	5000	2650	4050	1700
250	2	140	2950	2450	2250	1750	3950	1800	3200	1100
	4	140	3850	3350	2950	2400	5100	2550	4150	1600
	6	140	4500	3950	3400	2850	6100	2900	5000	1750
280	2	140	4350	2350	3450	1450	5750	1350	4850	450
	4	140	5400	3400	4250	2250	7400	2100	6200	900
	6	140	6200	4200	4850	2850	8300	2650	6900	1250
315	2	140	4150	2150	3300	1300	6100	450	-	-
	4	170	6600	4600	5100	3100	9250	2300	7700	750
	6	170	7550	5550	5800	3800	10850	2600	9050	750
355	2	140	4900	3200	3800	2100	8300	600	-	-
	4	210	8050	6300	6100	4350	12750	2700	10750	700
	6	210	9250	7500	6950	5200	14650	2950	12300	600

Terminal box

Standard terminal box

Terminal boxes

The pictures below show standard terminal boxes.

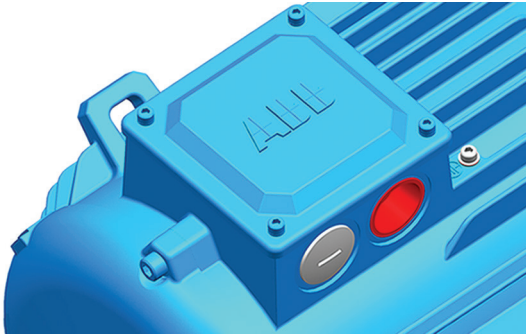

Terminal box for Motor sizes 71 to 132.

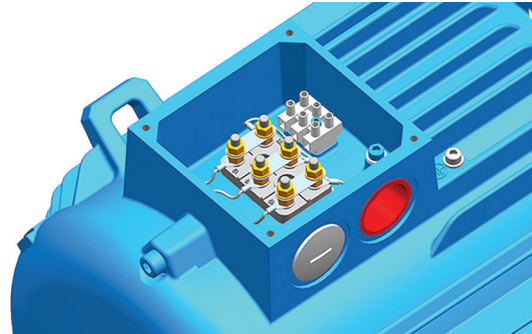

Terminal board for Motor sizes 71 to 132.

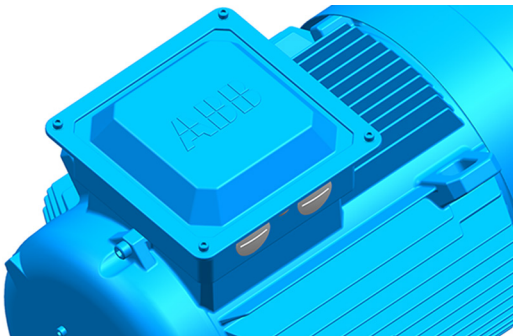

Terminal box for Motor sizes 160 to 180.

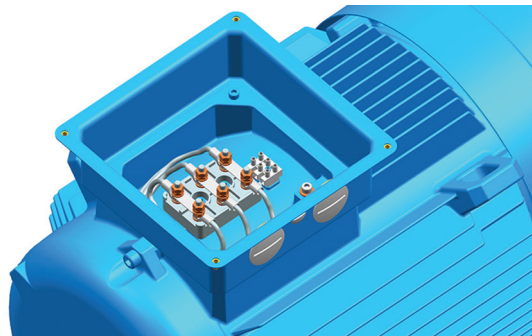

Terminal board for Motor size 160 to 180.

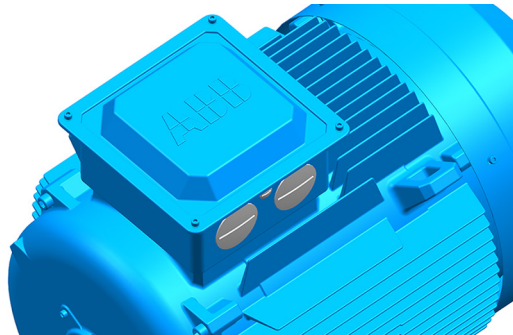

Terminal box for motor size 200 to 250.

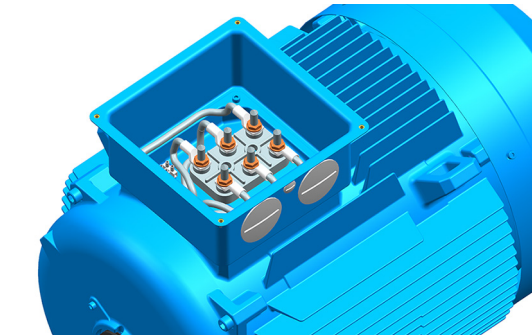

Terminal board for motor size 200 to 250.

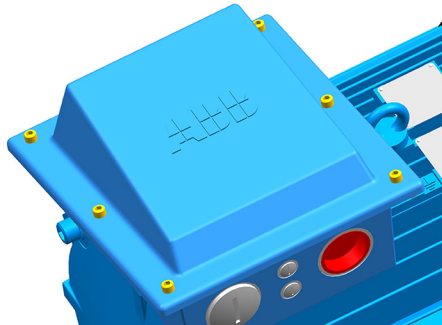

Terminal box for motors size 280 to 355.

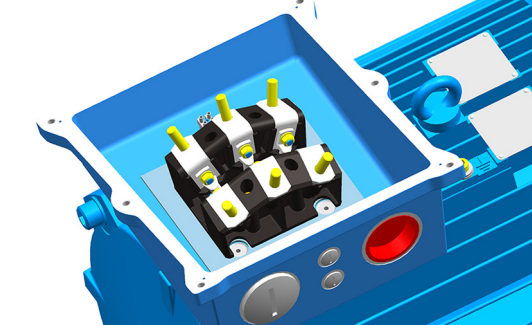

Terminal board for motor size 280 to 355.

Dimension drawings

IE3 and IE2 General performance cast iron motors

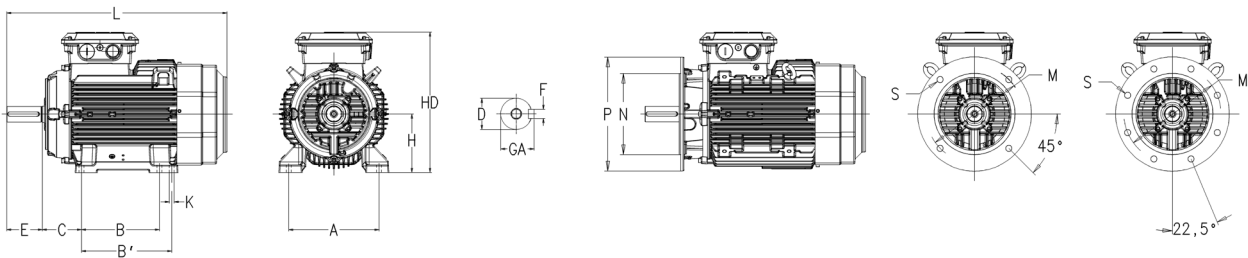

Foot-mounted motor IM1001, B3 and Flange-mounted motor IM 3001, B5

General performance cast iron motors M2BAX

Motor size	D poles		GA poles		F poles		E poles		L max poles		A	B	B'	C	HD	K	M	N	P	S	
	2	4-6	2	4-6	2	4-6	2	4-6	2	4-6											
71M	14	14	16	16	5	5	30	30	257	257	112	90	-	45	175	7	130	110	160	10	
71ML	14	14	16	16	5	5	30	30	282	282	112	90	-	45	175	7	130	110	160	10	
80M	19	19	21.5	21.5	6	6	40	40	309	309	125	100	-	50	192	10	165	130	200	12	
80ML	19	19	21.5	21.5	6	6	40	40	334	334	125	100	112	50	192	10	165	130	200	12	
90S	24	24	27	27	8	8	50	50	335	335	140	100	-	56	217	10	165	130	200	12	
90SL	24	24	27	27	8	8	50	50	351	351	140	100	125	56	217	10	165	130	200	12	
90L ¹⁾	24	24	27	27	8	8	50	50	351	351	140	125	-	56	217	10	165	130	200	12	
90L ²⁾	24	24	27	27	8	8	50	50	386	386	140	125	-	56	217	10	165	130	200	12	
100L	28	28	31	31	8	8	60	60	376	376	160	140	-	63	240	12	215	180	250	14.5	
100LK	28	28	31	31	8	8	60	60	411	411	160	140	160	63	240	12	215	180	250	14.5	
112M	28	28	31	31	8	8	60	60	411	411	190	140	-	70	252	12	215	180	250	14.5	
112ML	28	28	31	31	8	8	60	60	456	456	190	140	159	70	252	12	215	180	250	14.5	
132S	38	38	41	41	10	10	80	80	479	479	216	140	-	89	302	12	265	230	300	14.5	
132SM	38	38	41	41	10	10	80	80	521	521	216	140	178	89	302	12	265	230	300	14.5	
132M	38	38	41	41	10	10	80	80	521	521	216	178	-	89	302	12	265	230	300	14.5	
132ML	38	38	41	41	10	10	80	80	586	586	216	178	203	89	302	12	265	230	300	14.5	
160 MLA 2	42	42	45	45	12	12	110	110	639	639	254	210	254	108	414	14.5	300	250	350	19	
160 MLB 2																					
160 MLA 4																					
160 MLA 6																					
160 MLC 2	42	42	45	45	12	12	110	110	696	696	254	210	254	108	414	14.5	300	250	350	19	
160 MLB 4																					
160 MLB 6																					
180	48	48	51.5	51.5	14	14	110	110	728	728	279	241	279	121	454	14.5	300	250	350	19	
200	55	55	59	59	16	16	110	110	809	809	318	267	305	133	515	18.5	350	300	400	19	
225	55	60	59	64	16	18	110	140	812	842	356	286	311	149	560	18.5	400	350	450	19	
250	60	65	64	69	18	18	140	140	853	853	406	311	349	168	613	24	500	450	550	19	
280	65	75	69	79.5	18	20	140	140	1052	1056	457	368	419	190	771	24	500	450	550	18.5	
315 SM ₋	65	80	69	85	18	22	140	170	1220	1250	508	406	457	216	845	28	600	550	660	24	
315 ML ₋	65	90	69	95	18	25	140	170	1326	1356	508	457	508	216	845	28	600	550	660	24	
355	70	100	74.5	106	20	28	140	210	1403	1473	610	500	560	254	929	35	740	680	800	24	

Tolerances		Footnotes
A, B	±0,4	¹⁾ M2BAX IE2
D	ISO k6 < Ø 50 mm	²⁾ M2BAX IE3
	ISO m6 > Ø 50 mm	
F	ISO h9	
H	-0,5	
N	ISO j6	
C	±0,8	

Motors in brief

IE3/IE2 General performance cast iron motors, sizes 71 - 112

Motor size	M2BAX	71	80	90	100	112
Stator and end shields	Material	Cast iron				
	Paint color shade	Munsell blue 8B 4.5/3.25				
	Corrosion class	C3 medium				
Feet	Material	Integrated cast iron				
Bearings	D-end	6203-2Z/C3	6204-2Z/C3	6205-2Z/C3	6206-2Z/C3	6206-2Z/C3
	N-end	6202-2Z/C3	6203-2Z/C3	6204-2Z/C3	6205-2Z/C3	6205-2Z/C3
Axially locked bearings		Locked at D-end with retaining ring				
Bearing seals	D-end	V-ring				
	N-end	V-ring				
Lubrication		Permanently lubricated shielded bearings				
Measuring nipples for condition monitoring of the bearings		Not Included				
Rating plate	Material	Stainless steel				
Terminal box	Material	Steel				
	Corrosion class	C3 medium				
	Cover screws	Zinc-electroplated steel				
Connections	Threaded openings	2xM16, 1xM16	2xM25, 1xM16		2xM32, 1xM16	
	Max Cu-area mm	4	6		10	
	Terminals	6 terminals for connection with cable lugs (not included)				
	Cable glands	Glands as option				
Fan	Material	Glass-fiber reinforced polypropylene				
Fan cover	Material	Steel				
	Paint color shade	Munsell blue 8B 4.5/3.25				
	Corrosion class	C3 medium				
Stator winding	Material	Copper				
	Insulation	Insulation class F. Temperature rise class B unless otherwise stated.				
	Winding protection	3 PTC thermistors, 150°C				
Rotor winding	Material	Pressure die-cast aluminum				
Balancing method		Half key balancing as standard				
Key ways		Open key way				
Drain holes		Drain holes with closable plastic plugs, open on delivery				
Enclosure		IP 55 Higher protection on request				
Cooling method		IC 411				
Lifting lugs		Integrated cast iron lifting lugs				

Motors in brief

IE3/IE2 General performance cast iron motors, sizes 132 - 250

Motor size	M2BAX	132	160	180	200	225	250
Stator and end shields	Material	Cast iron					
	Paint color shade	Munsell blue 8B 4.5/3.25					
	Corrosion class	C3 (medium)					
Feet	Material	Integrated cast iron feet					
Bearings	D-end	6208-2Z/C3	6209-2Z/C3	6210-2Z/C3	6212/C3	6213-2Z/C3	6215-2Z/C3
	N-end	6208-2Z/C3	6209-2Z/C3	6209-2Z/C3	6209-2Z/C3	6210-2Z/C3	6212-2Z/C3
Axially locked bearings		Locked at D-end with retaining ring	Locked at D-end with inner bearing cover				
Bearing seals	D-end	V-ring					
	N-end	V-ring					
Lubrication		Permanently lubricated shielded bearings					
Measuring nipples for condition monitoring of the bearings		Not Included					
Rating plate	Material	Stainless steel					
Terminal box	Material	Steel					
	Corrosion class	C3 (medium)					
	Cover screws	Zinc-electroplated steel					
Connections	Threaded openings	2xM32	2xM40, 1xM16		2xM63, 1xM16		
	Terminals	6 terminals for connection with cable lugs (not included)					
	Cable glands	Glands as option	Cable flange included, glands as option				
Fan	Material	Glass-fiber reinforced polypropylene					
Fan cover	Material	Steel					
	Paint color shade	Munsell blue 8B 4.5/3.25					
	Corrosion class	C3 (medium)					
Stator winding	Material	Copper					
	Insulation	Insulation class F. Temperature rise class B unless otherwise stated.					
	Winding protection	3 PTC thermistors, 150 °C					
Rotor winding	Material	Pressure die-cast aluminum					
Balancing method		Half-key balancing as standard					
Key ways		Open key way					
Drain holes		Drain holes with closable plastic plugs, open on delivery					
Enclosure		IP 55 Higher protection on request					
Cooling method		IC 411					
Lifting lugs		Integrated cast iron lifting lug					

Motors in brief

IE3/IE2 General performance cast iron motors, sizes 280 - 355

Motor size	M2BAX	280	315	355
Stator and end shields	Material	Cast iron		
	Paint color shade	Munsell blue 8B 4.5/3.25		
	Corrosion class	C3 medium		
Feet		Integrated cast iron		
Bearings	D-end 2-pole	6217/C3	6217/C3	6219/C3
	D-end 4-6 -pole	6217/C3	6219/C3	6222/C3
	N-end 2-pole	6217/C3	6217/C3	6219/C3
	N-end 4-6 -pole	6217/C3	6217/C3	6219/C3
Axially locked bearings		Locked at D-end with inner bearing cover		
Bearing seals	D-end	V-ring		
	N-end	V-ring		
Lubrication		Regreasable bearings, regreasing nipples M6x1		
Measuring nipples for condition monitoring of the bearings		Not included		
Rating plate	Material	Stainless steel		
Terminal box	Material frame	Cast iron		
	Cover	Cast iron terminal box cover		
	Corrosion class	C3 medium		
	Screws	Zinc-electroplated steel		
Connections	Threaded openings	2xM63, 2 x M20	2xM63, 2 x M20	2xM75, 2 x M20
	Terminals	6 terminals for connection with cable lugs (not included)		
	Cable glands	Cable glands as option		
Fan	Material	Glass-fiber reinforced polypypropylene / 2-pole metal.		
Fan cover	Material	Steel fan cover		
	Paint color shade	Black / Munsell blue 8B 4.5/3.25		
	Corrosion class	C3 medium		
Stator winding	Material	Copper		
	Insulation	Insulation class F. Temperature rise class B unless otherwise stated.		
	Winding protection	3 PTC thermistors, 150 °C		
Rotor winding	Material	Pressure diecast aluminum		
Balancing method		Half key balancing as standard		
Keyway		Open key way		
Heating elements	On request	60 W	2x60 W	2x60 W
Enclosure		IP 55 Higher protection on request		
Cooling method		IC 411		
Drain holes		Drain holes with closable plastic plugs, open on delivery		
Lifting lugs		Bolted lifting lugs		

IE2 General performance cast iron motors

Sizes 71 to 355, 0.18 to 355 kW

Ordering information	36
Technical data	37
3000 r/min motors.....	37
1500 r/min motors.....	38
1000 r/min motors.....	39
Variant codes	40
Dimension drawings	42
Motors in brief	43
Motor sizes 71 - 132.....	43
Motor sizes 160 - 250.....	44
Motor sizes 280 - 355.....	45

Ordering information

Explanation of the product code

Motor type	Motor type	Product code	Mounting arrangement code, Voltage and frequency code, Generation code	Variant codes
M2BA	112MB	3GBA 112 212 - ADB		122, etc.
		1 2 3 4 5 6 7 8 9 10 11 12 13 14		

When placing an order, please state the following minimum data in the order, as in example

The product code of the motor is composed in accordance with the following example.

Example

Motor type	M2BA 112 MB
Pole number	4
Mounting arrangement (IM-code)	IM B3 (IM 1001)
Rated output	4 kW
Product code	3GBA 112 212-ADB
Variant codes if needed	

Positions 1 to 4

3GBA:	Totally enclosed motor with cast iron frame
-------	---

Positions 4

Type of rotor	
A:	Squirrel cage rotor

Positions 5 and 6

IEC size	
07:	71
08:	80
09:	90
10:	100
11:	112
13:	132
16:	160
18:	180
20:	200
22:	225
25:	250
28:	280
31:	315
35:	355

Position 7

Pole pairs	
1:	2 poles
2:	4 poles
3:	6 poles

Positions 8 to 10

Running number	
----------------	--

Position 11

- (dash)	
----------	--

Position 12

Mounting arrangement	
A:	Foot-mounted motor
B:	Flange-mounted motor. Large flange with clearance holes.
C:	Flange-mounted motor. Small flange with tapped holes.
F:	Foot- and flange-mounted motor. Special flange.
H:	Foot- and flange-mounted motor. Large flange with clearance holes.
J:	Foot- and flange-mounted motor. Small flange with tapped holes.
N:	Flange-mounted (CI ring flange FF)
P:	Foot-and flange-mounted motor (CI ring flange FF)

Position 13

Voltage and frequency	
Single-speed motors	
D:	400 VΔ, 415 VΔ, 460 VΔ, 690 VY 50 Hz
S:	230 VΔ, 400 VY, 415 VY 50 Hz, 460 VΔ 60 Hz*)

Position 14

Version A, B, C... = Generation code followed by variant codes	
---	--

*) M2AA 200 is not available for voltages less than 380 VD

Efficiency values are given according to IEC 60034-2-1; 2014

For detailed dimension drawings please see our web-pages 'www.abb.com/motors&generators' or contact ABB.

Note! The M2BA serie will be replaced by the M2BAX serie within year 2016. We apologize for any inconvenience this update may cause you. If the product you wish to order is out of stock please use the respective M2BA or M2BAX motor which is available.

Technical data

IE2 General performance cast motors, 3000 r/min

IP 55 - IC 411 - Insulation class F, temperature rise class B
IE2 efficiency class according to IEC 60034-30-1; 2014

Output kW	Motor type	Product code	Speed r/min	Efficiency IEC 60034-30-1; 2014			Power factor Cos ϕ	Current Torque					Moment of inertia J = 1/4 GD ² kgm ²	Weight kg	Sound pressure Level L _{PA} dB
				Full load 100%	3/4 load 75%	1/2 load 50%		I _N A	I _s /I _N	T _N Nm	T _r /T _N	T _v /T _N			
3000 r/min = 2 poles				400 V 50 Hz				GENELEC-design							
0.37	M2BA 71MA 2	3GBA071211-••B	2768	74,8	75,4	72,4	0,78	0,89	4,5	1,27	2,2	2,3	0,000390	11	58
0.55	M2BA 71MB 2	3GBA071212-••B	2813	77,8	78,3	76,0	0,79	1,29	4,3	1,86	2,4	2,5	0,000510	11	56
0.75	M2BA 80MB 2	3GBA081212-••B	2895	80,6	79,6	75,6	0,74	1,8	7,7	2,4	4,2	4,2	0,0010	16	57
1.1	M2BA 80MC 2	3GBA081213-••B	2870	81,8	81,7	78,9	0,80	2,44	7,5	3,6	3,7	4,6	0,00120	18	60
1.5	M2BA 90SLB 2	3GBA091212-••B	2900	82,2	82,9	81,3	0,87	3,26	7,5	4,9	2,5	2,6	0,00254	24	69
2.2	M2BA 90SLC 2	3GBA091213-••B	2885	84,7	86,8	85,7	0,88	4,2	6,8	7,2	1,9	2,5	0,00280	25	64
3	M2BA 100LB 2	3GBA101212-••B	2925	85,2	84,9	82,7	0,87	5,75	9,1	9,7	3,1	3,5	0,00528	36	68
4	M2BA 112MB 2	3GBA111212-••B	2895	86,1	87,0	86,6	0,89	7,52	8,1	13,1	2,9	3,2	0,00575	37	70
5.5	M2BA 132SMB 2	3GBA131212-••B	2865	87,7	88,4	87,7	0,86	10,0	7,0	18,3	2,6	2,7	0,0128	68	70
7.5	M2BA 132SMC 2	3GBA131214-••B	2890	88,2	88,5	87,5	0,88	13,7	7,3	24,9	2,6	3,6	0,0136	70	70
11	M2BA 160MLA 2	3GBA161044••-G	2920	89,8	91,0	90,6	0,89	19,8	5,9	35,9	1,6	2,7	0,0380	119	69
15	M2BA 160MLB 2	3GBA161045••-G	2934	91,1	92,2	92,0	0,90	26,4	7,0	48,8	2,5	3,1	0,0480	133	69
18.5	M2BA 160MLC 2	3GBA161046••-G	2934	90,9	91,8	91,2	0,89	32,9	7,3	60,2	2,6	3,2	0,0520	141	73
22	M2BA 180MLA 2	3GBA181042••-G	2933	91,5	92,7	92,7	0,90	38,1	7,8	71,6	3,0	3,5	0,0620	173	73
30	M2BA 200MLA 2	3GBA201043••-G	2950	92,2	92,8	92,2	0,89	52,7	7,8	97,1	2,7	3,3	0,0920	214	75
37	M2BA 200MLB 2	3GBA201044••-G	2947	92,5	93,0	92,5	0,90	63,4	7,7	119	2,8	3,6	0,116	240	75
45	M2BA 225SMA 2	3GBA221042••-G	2956	93,0	93,5	92,8	0,90	77,6	8,1	145	3,1	3,4	0,197	297	75
55	M2BA 250SMA 2	3GBA251042••-G	2960	93,9	94,3	93,6	0,90	93,9	6,8	177	2,6	2,5	0,275	339	75
75	M2BA 280SA 2	3GBA281110-••L	2977	94,0	93,7	92,3	0,88	130	7,6	240	2,1	3,0	0,80	530	78
90	M2BA 280SMB 2	3GBA281220-••L	2976	94,3	94,2	93,1	0,90	153	7,4	288	2,1	2,9	0,90	570	78
110	M2BA 315SMA 2	3GBA311210-••L	2982	94,6	94,1	92,7	0,86	195	7,6	352	2,0	3,0	1,20	750	78
132	M2BA 315SMB 2	3GBA311220-••L	2982	94,9	94,6	93,4	0,88	228	7,4	422	2,2	3,0	1,40	810	78
160	M2BA 315SMC 2	3GBA311230-••L	2981	95,2	95,0	94,1	0,89	272	7,5	512	2,3	3,0	1,70	900	78
200	M2BA 315MLA 2	3GBA311410-••L	2980	95,3	95,2	94,4	0,90	336	7,7	640	2,6	3,0	2,10	1020	83
250	M2BA 355SMA 2	3GBA351210-••L	2983	95,4	95,2	94,3	0,89	424	6,8	800	1,5	2,8	2,70	1310	83
315	M2BA 355SMB 2	3GBA351220-••L	2980	95,4	95,4	94,7	0,89	535	7,2	1009	1,9	2,8	3,40	1450	83
355	M2BA 355SMC 2	3GBA351230-••L	2983	95,5	95,5	94,9	0,88	609	7,4	1136	2,1	2,7	3,60	1520	83

Note! The M2BA series will be replaced by the M2BAX series within year 2016. We apologize for any inconvenience this update may cause you. If the product you wish to order is out of stock please use the respective M2BA or M2BAX motor which is available.

Technical data

IE2 General performance cast iron motors, 1500 r/min

IP 55 - IC 411 - Insulation class F, temperature rise class B
IE2 efficiency class according to IEC 60034-30-1; 2014

Output kW	Motor type	Product code	Speed r/min	Efficiency IEC 60034-30-1; 2014			Power factor Cosφ	Current Torque					Moment of inertia J = 1/4 GD ² kgm ²	Weight kg	Sound pressure Level L _{PA} dB
				Full load 100%	3/4 load 75%	1/2 load 50%		I _N A	I _s /I _N	T _N Nm	T _f /T _N	T _b /T _N			
1500 r/min = 4 poles				400 V 50 Hz			GENELEC-design								
0.25	M2BA 71MA 4	3GBA072211-••B	1365	68,3	70,7	69,6	0,81	0,63	3,5	1,74	1,9	2,0	0,000740	10	45
0.37	M2BA 71MB 4	3GBA072212-••B	1380	72,4	74,5	74,7	0,83	0,87	4,6	2,5	1,6	2,1	0,000880	11	45
0.55	M2BA 80MA 4	3GBA082211-••B	1415	70,0	69,2	64,7	0,73	1,44	5,0	3,7	2,0	2,8	0,00144	15	45
0.75	M2BA 80MD 4	3GBA082214-••B	1430	81,0	81,0	78,2	0,73	1,82	5,3	5,0	2,7	3,2	0,00205	17	50
1.1	M2BA 90SLB 4	3GBA092212-••B	1435	83,6	84,1	82,4	0,80	2,36	6,5	7,3	2,4	3,4	0,00440	25	50
1.5	M2BA 90SLD 4	3GBA092215-••B	1430	84,3	85,1	83,9	0,83	3,0	6,3	10,0	2,7	3,4	0,00530	27	56
2.2	M2BA 100LC 4	3GBA102213-••B	1450	85,9	85,1	83,4	0,78	4,6	7,7	14,5	2,7	4,1	0,00948	36	56
3	M2BA 100LD 4	3GBA102214-••B	1450	86,8	86,9	85,3	0,79	6,1	7,7	19,8	2,9	3,4	0,0110	38	58
4	M2BA 112MB 4	3GBA112212-••B	1440	86,8	87,7	87,3	0,82	7,9	7,0	26,5	2,5	2,9	0,0125	44	59
5.5	M2BA 132SMB 4	3GBA132212-••B	1460	89,0	89,8	88,9	0,80	10,8	6,7	36,0	2,2	3,2	0,0328	70	67
7.5	M2BA 132SMC 4	3GBA132213-••B	1450	89,3	90,1	90,0	0,81	14,5	7,2	49,4	2,5	3,5	0,0366	73	64
11	M2BA 160MLA 4	3GBA162043-••G	1463	90,1	91,4	91,2	0,85	20,7	7,1	71,7	2,6	3,0	0,0840	134	65
15	M2BA 160MLB 4	3GBA162044-••G	1463	90,6	91,8	91,6	0,84	28,4	7,2	97,9	2,7	3,6	0,0950	141	65
18.5	M2BA 180MLA 4	3GBA182043-••G	1464	91,2	92,3	92,1	0,84	34,8	7,9	120	3,1	3,6	0,112	175	62
22	M2BA 180MLB 4	3GBA182044-••G	1465	91,6	92,5	92,1	0,83	41,7	8,0	143	3,0	3,8	0,130	187	65
30	¹⁾ M2BA 200MLA 4	3GBA202042-••G	1474	92,2	93,4	93,5	0,83	56,5	7,3	194	2,7	2,9	0,217	241	62
37	M2BA 225SMA 4	3GBA222043-••G	1479	93,0	93,9	93,8	0,84	68,3	7,2	238	2,6	2,9	0,309	293	68
45	M2BA 225SMB 4	3GBA222044-••G	1479	93,2	94,0	93,7	0,83	83,9	7,4	290	2,4	3,1	0,368	318	68
55	M2BA 250SMA 4	3GBA252042-••G	1478	93,5	94,2	93,7	0,85	99,8	7,3	355	2,8	3,0	0,476	342	70
75	M2BA 280SA 4	3GBA282110-••L	1484	94,2	94,2	93,5	0,85	135	6,9	482	2,5	2,8	1,250	515	71
90	M2BA 280SMB 4	3GBA282220-••L	1483	94,4	94,6	94,1	0,86	160	7,2	579	2,5	2,7	1,50	575	71
110	M2BA 315SMA 4	3GBA312210-••L	1487	94,7	94,6	93,8	0,86	194	7,2	706	2,0	2,5	2,30	775	78
132	M2BA 315SMB 4	3GBA312220-••L	1487	95,0	95,0	94,3	0,86	233	7,1	847	2,3	2,7	2,60	830	78
160	M2BA 315SMC 4	3GBA312230-••L	1487	95,2	95,3	94,6	0,85	285	7,2	1027	2,4	2,9	2,90	870	78
200	M2BA 315MLA 4	3GBA312410-••L	1486	95,3	95,4	94,9	0,86	352	7,0	1285	2,3	2,8	3,50	995	78
250	M2BA 355SMA 4	3GBA352210-••L	1488	95,2	95,2	94,4	0,85	445	6,7	1604	2,0	2,6	5,40	1400	82
315	M2BA 355SMB 4	3GBA352220-••L	1488	95,5	95,5	94,8	0,85	560	7,3	2021	2,2	2,7	6,90	1570	82
355	M2BA 355SMC 4	3GBA352230-••L	1487	95,5	95,7	95,2	0,86	623	6,8	2279	2,4	2,7	7,20	1650	82

¹⁾ Temperature rise class F

Note! The M2BA serie will be replaced by the M2BAX serie within year 2016. We apologize for any inconvenience this update may cause you. If the product you wish to order is out of stock please use the respective M2BA or M2BAX motor which is available.

Technical data

IE2 General performance cast iron motors, 1000 r/min

IP 55 - IC 411 - Insulation class F, temperature rise class B
IE2 efficiency class according to IEC 60034-30-1; 2014

Output kW	Motor type	Product code	Speed r/min	Efficiency IEC 60034-30-1; 2014			Power factor Cos ϕ	Current Torque					Moment of inertia J = 1/4 GD ² kgm ²	Weight kg	Sound pressure Level L _{PA} dB
				Full load 100%	3/4 load 75%	1/2 load 50%		I _N A	I _s /I _N	T _N Nm	T _r /T _N	T _v /T _N			
1000 r/min = 6 poles				400 V 50 Hz				GENELEC-design							
0.18	M2BA 71MA 6	3GBA073211-••B	900	63,7	63,8	59,0	0,71	0,57	3,1	1,91	2,0	2,1	0,000890	10	42
0.25	M2BA 71MB 6	3GBA073212-••B	915	67,2	65,5	59,5	0,69	0,77	3,7	2,6	2,6	2,7	0,00110	12	42
0.37	M2BA 80MA 6	3GBA083211-••B	925	71,0	70,0	65,0	0,69	1,09	4,1	3,8	2,4	2,5	0,00187	15	47
0.55	M2BA 80MB 6	3GBA083212-••B	920	73,1	74,2	71,9	0,71	1,51	3,8	5,7	1,8	2,2	0,00239	17	47
0.75	M2BA 90SLC 6	3GBA093213-••B	960	78,7	77,2	72,5	0,58	2,3	4,5	7,4	2,4	3,1	0,00491	25	44
1.1	M2BA 90SLE 6	3GBA093214-••B	930	78,2	78,7	76,5	0,66	3,0	4,0	11,2	1,9	2,3	0,00540	28	44
1.5	M2BA 100L 6	3GBA103212-••B	950	82,2	83,0	81,6	0,69	3,7	4,3	15,0	1,5	2,7	0,00873	37	49
2.2	M2BA 112MB 6	3GBA113212-••B	950	82,5	83,7	81,6	0,69	5,5	4,4	22,1	1,7	2,3	0,0125	44	66
3	M2BA 132SMB 6	3GBA133211-••B	975	85,3	84,2	81,2	0,63	8,0	5,5	29,4	1,8	2,9	0,0334	69	57
4	M2BA 132SMC 6	3GBA133212-••B	960	84,9	85,3	83,9	0,68	10,0	4,6	39,7	1,5	2,2	0,0334	69	57
5.5	M2BA 132SMF 6	3GBA133214-••B	965	86,1	86,5	85,4	0,71	12,9	5,1	54,4	2,0	2,3	0,0487	86	57
7.5	M2BA 160MLA 6	3GBA163043••-G	971	87,6	89,1	89,0	0,79	15,6	7,1	73,7	1,9	3,3	0,0890	141	61
11	M2BA 160MLB 6	3GBA163044••-G	970	88,6	90,0	89,9	0,79	22,6	7,6	108	2,1	3,3	0,119	157	61
15	M2BA 180MLA 6	3GBA183042••-G	971	89,7	90,8	90,5	0,76	31,7	7,8	147	2,5	4,1	0,137	187	61
18.5	M2BA 200MLA 6	3GBA203043••-G	975	90,7	92,0	91,9	0,79	37,2	5,9	181	1,7	2,7	0,198	228	65
22	M2BA 200MLB 6	3GBA203044••-G	974	91,0	92,4	92,5	0,79	44,1	5,8	215	1,8	2,6	0,222	241	65
30	M2BA 225SMA 6	3GBA223042••-G	985	92,2	93,1	93,1	0,83	56,5	6,9	290	2,4	2,8	0,532	318	65
37	M2BA 250SMA 6	3GBA253042••-G	985	92,3	93,2	92,9	0,83	69,6	6,6	358	2,4	2,8	0,718	336	66
45	M2BA 280SA 6	3GBA283110-••L	990	92,8	93,0	92,1	0,84	83,3	7,0	434	2,5	2,5	1,850	500	71
55	M2BA 280SB 6	3GBA283120-••L	990	93,3	93,5	92,9	0,84	101	7,0	530	2,7	2,6	2,20	540	71
75	M2BA 315SMA 6	3GBA313210-••L	992	94,0	94,0	93,0	0,81	142	7,0	721	2,1	2,7	3,20	705	75
90	M2BA 315SMB 6	3GBA313220-••L	992	94,3	94,4	93,6	0,83	165	7,2	866	2,1	2,7	4,10	800	75
110	M2BA 315SMC 6	3GBA313230-••L	992	94,7	94,8	94,2	0,83	201	7,0	1058	2,2	2,7	4,90	870	75
132	M2BA 315MLA 6	3GBA313410-••L	992	94,9	95,0	94,4	0,83	241	7,2	1270	2,4	2,7	5,80	980	75
160	M2BA 355SMA 6	3GBA353210-••L	992	94,9	95,0	94,4	0,83	293	6,2	1540	2,1	2,3	7,30	1290	77
200	M2BA 355SMB 6	3GBA353220-••L	992	95,2	95,4	94,9	0,84	360	6,5	1925	2,1	2,3	9,70	1440	77
250	M2BA 355SMC 6	3GBA353230-••L	991	95,3	95,5	95,2	0,84	450	6,7	2409	2,3	2,3	11,30	1590	77

Note! The M2BA series will be replaced by the M2BAX series within year 2016. We apologize for any inconvenience this update may cause you. If the product you wish to order is out of stock please use the respective M2BA or M2BAX motor which is available at the moment.

Variant codes

IE2 General performance cast iron M2BA motors

Variant codes specify additional options and features to the standard motor. The desired features are listed as three-digit variant codes in the motor order. Note also that there are variants that cannot be used together.

Code, variants, M2BA	Frame size													
	71	80	90	100	112	132	160	180	200	225	250	280	315	355
Administration														
531 Sea freight packing	•	•	•	•	•	•	•	•	•	•	•	•	•	•
Bearings and Lubrication														
037 Roller bearing at D-end.	-	-	-	•	•	•	•	•	•	•	•	•	•	•
041 Bearings regreasable via grease nipples.	-	-	-	-	-	-	•	•	•	•	•	○	○	○
043 SPM compatible nipples for vibration measurement	•	•	•	•	•	•	•	•	•	•	•	•	•	•
188 63-series bearing in D-end	-	-	-	-	-	-	•	•	•	•	•	-	-	-
Branch standard designs														
178 Stainless steel / acid proof bolts.	•	•	•	•	•	•	•	•	•	•	•	•	•	•
Cooling system														
068 Light alloy metal fan	•	•	•	•	•	•	•	•	•	•	•	•	•	•
Drain holes														
065 Plugged existing drain holes.	•	•	•	•	•	•	•	•	•	•	•	•	•	•
Earthing Bolt														
067 External earthing bolt.	•	•	•	•	•	•	•	•	•	•	•	•	○	○
Heating elements														
450 Heating element, 100-120 V	•	•	•	•	•	•	•	•	•	•	•	•	•	•
451 Heating element, 200 - 240 V	•	•	•	•	•	•	•	•	•	•	•	•	•	•
Marine														
096 Fulfilling Lloyds Register of Shipping (LR) requirements, without certificate (non-essential duty only)	•	•	•	•	•	•	•	•	•	•	•	•	•	•
186 Fulfilling Det Norske Veritas (DNV) requirements, without certificate (non-essential duty only)	•	•	•	•	•	•	•	•	•	•	•	•	•	•
492 Fulfilling Registro Italiano Navale (RINA) requirements, without certificate.	•	•	•	•	•	•	•	•	•	•	•	•	•	•
496 Fulfilling Bureau Veritas (BV) requirements, without certificate(non-essential duty only)	•	•	•	•	•	•	•	•	•	•	•	•	•	•
675 Fulfilling American Bureau of Shipping (ABS) requirements, without certificate (non-essential duty only)	•	•	•	•	•	•	•	•	•	•	•	•	•	•
676 Fulfilling Germanischer Lloyd (GL) requirements, without certificate (non-essential duty only)	•	•	•	•	•	•	•	•	•	•	•	•	•	•
Mounting arrangements														
008 IM 2101 foot/flange mounted, IEC flange, from IM 1001 (B34 from B3).	•	•	•	•	•	•	-	-	-	-	-	-	-	-
009 IM 2001 foot/flange mounted, IEC flange, from IM 1001 (B35 from B3).	•	•	•	•	•	•	•	•	•	•	•	•	•	•
047 IM 3601 flange mounted, IEC flange, from IM 3001 (B14 from B5).	•	•	•	•	•	•	•	•	•	•	•	•	•	•
048 IM 3001 flange mounted, IEC flange, from IM 3601 (B5 from B14).	•	•	•	•	•	•	-	-	-	-	-	-	-	-
066 Modified for specified mounting position differing from IM B3 (1001), IM B5 (3001), B14 (3601), IM B35 (2001), IM B34 (2101)	•	•	•	•	•	•	•	•	•	•	•	•	•	•
Painting														
114 Special paint color, standard grade	•	•	•	•	•	•	•	•	•	•	•	•	•	•
Protection														
005 Protective roof, vertical motor, shaft down.	•	•	•	•	•	•	•	•	•	•	•	•	•	•
072 Radial seal at D-end. Not possible for 2-pole , 280 and 315 frames	•	•	•	•	•	•	•	•	•	•	•	•	•	•
158 Degree of protection IP65.	•	•	•	•	•	•	•	•	•	•	•	•	•	•
403 Degree of protection IP56.	•	•	•	•	•	•	•	•	•	•	•	•	•	•
Rating & instruction plates														
002 Restamping voltage, frequency and output, continuous duty.	•	•	•	•	•	•	•	•	•	•	•	•	•	•
095 Restamping output (maintained voltage, frequency), intermittent duty.	•	•	•	•	•	•	•	•	•	•	•	•	•	•
135 Mounting of additional identification plate, stainless.	•	•	•	•	•	•	•	•	•	•	•	•	•	•
159 Additional plate with text "Made in ..."	•	•	•	•	•	•	•	•	•	•	•	•	•	•
161 Additional rating plate delivered loose.	•	•	•	•	•	•	•	•	•	•	•	•	•	•
163 Frequency converter rating plate. Rating data according to quotation.	•	•	•	•	•	•	•	•	•	•	•	•	•	•
Standards and Regulations														
331 IE1 motor not for sale for use in EU	•	•	•	•	•	•	•	•	•	•	•	•	•	•
Stator winding temperature sensors														
122 Bimetal detectors, break type (NCC), (3 in series), 150 °C, in stator winding	•	•	•	•	•	•	•	•	•	•	•	•	•	•

○ = Included as standard | • = Available as option | - = Not applicable

Code, variants, M2BA	Frame size													
	71	80	90	100	112	132	160	180	200	225	250	280	315	355
435 PTC - thermistors (3 in series), 130 °C, in stator winding	•	•	•	•	•	•	•	•	•	•	•	•	•	•
436 PTC - thermistors (3 in series), 150 °C, in stator winding	○	○	○	○	○	○	○	○	○	○	○	○	○	○
439 PTC - thermistors (2x3 in series), 150 °C, in stator winding	•	•	•	•	•	•	•	•	•	•	•	•	•	•
441 PTC - thermistors (3 in series, 130 °C & 3 in series, 150 °C), in stator winding	•	•	•	•	•	•	•	•	•	•	•	•	•	•
445 Pt100 2-wire in stator winding, 1 per phase	•	•	•	•	•	•	•	•	•	•	•	•	•	•
Terminal box														
230 Standard metal cable gland.	•	•	•	•	•	•	•	•	•	•	•	•	•	•
447 Top mounted separate terminal box for monitoring equipment	-	-	-	-	-	-	-	-	-	-	-	•	•	•
Testing														
148 Routine test report.	•	•	•	•	•	•	•	•	•	•	•	•	•	•
Variable speed drives														
701 Insulated bearing at N-end.	-	-	-	-	-	-	-	-	-	-	-	-	•	•
704 EMC cable entry.	•	•	•	•	•	•	•	•	•	•	•	•	•	•

○ = Included as standard | • = Available as option | - = Not applicable

Dimension drawings

IE2 General performance cast iron motors, sizes 71 - 355

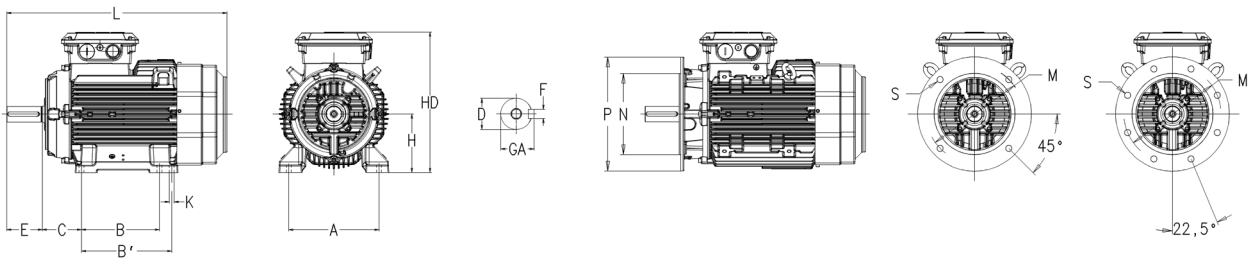

Foot-mounted motor IM1001, B3 and Flange-mounted motor IM 3001, B5

General performance cast iron motors M2BA

Motor size	D poles		GA poles		F poles		E poles		L max poles		A	B	B'	C	HD	K	H	M	N	P	S
	2	4-6	2	4-6	2	4-6	2	4-6	2	4-6											
71	14	14	16	16	5	5	30	30	264	264	112	90	-	45	178	7	71	130	110	160	10
80	19	19	21.5	21.5	6	6	40	40	321	321	125	100	-	50	195	10	80	165	130	200	12
90	24	24	27	27	8	8	50	50	357	357	140	100	125	56	219	10	90	165	130	200	12
100	28	28	31	31	8	8	60	60	381	381	160	140	-	63	247	12	100	215	180	250	15
112	28	28	31	31	8	8	60	60	403	403	190	140	-	70	259	12	112	215	180	250	15
132	38	38	41	41	10	10	80	80	533	533	216	140	178	89	300	12	132	265	230	300	15
160	42	42	45	45	12	12	110	110	584	584 ⁵⁾	254	210	254	108	413	14.5	160	300	250	350	19
180	48	48	51.5	51.5	14	14	110	110	681	681	279	241	279	121	433	14.5	180	300	250	350	19
200	55	55	59	59	16	16	110	110	726	726	318	267	305	133	473 ⁶⁾	18.5	200	350	300	400	19
225	55	60	59	64	16	18	110	140	821	851	356	286	311	149	539	18.5	225	400	350	450	19
250	60	65	64	69	18	18	140	140	879	879	406	311	349	168	584	24	250	500	450	550	19
280S	65	75	69	79.5	18	20	140	140	982	982	457	368	-	190	768	24	280	500	450	550	18
280SM	65	75	69	79.5	18	20	140	140	1052	1052	457	368	419	190	768	24	280	500	450	550	18
315SM	65	80	69	85	18	22	140	170	1216	1246	508	406	457	216	845	28	315	600	550	660	23
315ML	65	90	69	85	18	25	140	170	1330	1360	508	457	508	216	845	28	315	600	550	660	23
355SM	70	100	74.5	106	20	28	140	210	1399	1469	610	500	560	254	926	35	355	740	680	800	23

Motor size	M	N	P	S	Footnotes
71	85	70	105	M6	⁵⁾ 160MLB 6-pole L = 681
80	100	80	120	M6	⁶⁾ 200, voltage code S HD = 478
90	115	95	140	M8	
100	130	110	160	M8	
112	130	110	160	M8	
132	165	130	200	M10	

Tolerances

A, B	±0,8
D	ISO j6 ≤ Ø 28 mm ISO k6 < Ø 38 mm ISO m6 ≥ Ø 55 mm
F	ISO h9
H	-0,5
N	ISO js6
C	±0,8

Motors in brief

IE2 General performance cast iron motors, sizes 71 - 132

Motor size	M2BA	71	80	90	100	112	132
Stator and end shields	Material	Cast iron EN-GJL-150/GG 15/GRS 150					
	Paint color shade	Munsell blue 8B 4.5/3.25					
	Surface treatment	Phosphating anticorrosive primer and top coat polyurethane, $\geq 70\mu\text{m}$					
Feet	Material	Integrated cast iron feet					
Bearings	D-end	6203-2Z/C3	6204-2Z/C3	6205-2Z/C3	6206-2Z/C3	6206-2Z/C3	6208-2Z/C3
	N-end	6202-2Z/C3	6203-2Z/C3	6204-2Z/C3	6205-2Z/C3	6205-2Z/C3	6208-2Z/C3
Axially locked bearings		Locked at D-end					
Bearing seals	D-end	V-ring					
	N-end	Labyrinth seal					
Lubrication		Permanently lubricated shielded bearings. Grease temperature range -40 to + 160 °C					
Terminal box	Material	Cast iron EN-GJL-150/GG 15/GRS 150					
	Surface treatment	Phosphating anticorrosive primer and top coat polyurethane, $\geq 70\mu\text{m}$					
	Screws	Steel 5G, coated with zinc and yellow chromated.					
Connections	Threaded openings	2 x M16	2 x M25	2 x M32			
	Max Cu-area mm ²	4	6	10			
	Terminal box	Cable lugs, 6 terminals					
Fan	Material	Polypropylene. Reinforced with 20% glass-fibre.					
Fan cover	Material	Steel					
	Paint color shade	Black RAL 9011					
	Surface treatment	Phosphating pretreatment and polyester powder top coat $\geq 70\mu\text{m}$					
Stator winding	Material	Copper					
	Insulation class	Insulation class F.					
	Winding protection	3 PTC thermistors as standard, 150 °C					
Rotor winding	Material	Die-cast aluminum					
Balancing method		Half-key balancing					
Key ways		Closed key way					
HEating elements	On request	8 W			25 W		
Enclosure		IP 55					
Cooling method		IC 411					
Drain holes		Drain holes with closable plastic plugs, open on delivery.					
Lifting lugs		Bolted to the stator					

Motors in brief

IE2 General performance cast iron motors, sizes 160 - 250

Motor size	M2BA	160	180	200	225	250
Stator and end shields	Material	Cast iron EN-GJL-200/GG 20/GRS 200				
	Paint color shade	Munsell blue 8B 4.5/3.25 / NCS 4822 B05G				
	Surface treatment	Two-pack epoxy paint $\geq 70\mu\text{m}$				
Feet		Integrated with stator				
Bearing end shields	Material	Cast iron EN-GJL-200/GG 20/GRS 200				
	Paint color shade	Munsell blue 8B 4.5/3.25 / NCS 4822 B05G				
	Surface treatment	Two-pack epoxy paint $\geq 70\mu\text{m}$				
Bearings	D-end	6209-2Z/C3	6210-2Z/C3	6212-2Z/C3	6213-2Z/C3	6215-2Z/C3
	N-end	6209-2Z/C3	6209-2Z/C3	6209-2Z/C3	6210-2Z/C3	6212-2Z/C3
Axially locked bearings	Inner bearing cover	As standard, Locked at D-end				
Bearing seals	D-end	V-ring				
	N-end	V-ring				
Lubrication		Permanently lubricated shielded bearings.				
Rating plate	Material	Stainless steel				
Terminal box	Material	Cast iron, base integrated with stator.				
	Surface treatment	Two-pack epoxy paint $\geq 70\mu\text{m}$				
	Cover screws	Steel 8.8, zinc electroplated and chromated				
Connections	Threaded openings	2 x M40 + M16*)				(2 x M63 + M16)
	Max CU-area mm ²	35				
	Terminal box	6 terminals for connection with cable lugs (not included)				
	Screws	M6				M10
Fan	Material	Polypropylene. Reinforced with 20% glass-fibre.				
Fan cover	Material	Hot dip galvanized steel				
	Paint color shade	Black, NCS 8801-B09G				
	Surface treatment	Polyester powder paint $\geq 70\mu\text{m}$				
Stator winding	Material	Copper				
	Insulation	Insulation class F				
	Winding protection	3 PTC thermistors as standard, 150 °C				
Rotor winding	Material	Die-cast aluminum				
Balancing method		Half-key balancing				
Key ways		Closed key way				
Heating elements	On request	25 W			50 W	
Enclosure		IP 55				
Drain holes		Drain holes with closable plastic plugs, open on delivery				
Cooling method		IC 411				
Drain holes		Drain holes with closable plastic plugs, open on delivery.				
Lifting lugs		Integrated with the stator				

*) Frame size 200 code S

(2 x M63 + M16), max. CU-area 70 mm² and screws M10.

Motors in brief

IE2 General performance cast iron motors, sizes 280 - 355

Motor size	M2BA	280	315	355
Stator and end shields	Material	Cast iron EN-GJL-200		
	Paint color shade	Munsell blue 8B 4.5/3.25 / NCS 4822 B05G		
	Surface treatment	Two-pack epoxy paint, $\geq 70\mu\text{m}$		
Feet		Integrated with stator		
	Material	Cast iron EN-GJL-200		
Bearings	D-end 2-pole	6217/C3	6217/C3	6219/C3
	4-6 -pole	6217/C3	6219/C3	6222/C3
	N-end 2-pole	6217/C3	6217/C3	6219/C3
	4-6 -pole	6217/C3	6217/C3	6219/C3
Axially locked bearings	Inner bearing cover	D-end		
Bearing seals	D-end	V-ring		
	N-end	V-ring		
Lubrication		Regreasable bearings, regreasing nipples M10x1		
Rating plate	Material	Stainless steel		
Terminal box	Material frame	Cast iron EN-GJL-200		
	cover	Polypropylene. Reinforced with 25% glass fibre.		
	Surface treatment	Two-pack epoxy paint, $\geq 70\mu\text{m}$ (for terminal box frame)		
	Screws	Steel 5G, coated with zinc and blue chromated		
Connections	Threaded openings	2xM63, 2 x M20	2xM63, 2 x M20	2xM75, 2 x M20
	Max Cu-area mm ²	2x150	2x240	4x240
	Terminal box	Cable lugs, 6 terminals		
	Screws	M12	M12	M12
Fan	Material	Polypropylene. Reinforced with 25% glass fibre.		
Fan cover	Material	Polypropylene. Reinforced with 25% glass fibre.		
	Paint color shade	Black plastic, no painting		
	Surface treatment	No surface treatment		
Stator winding	Material	Copper		
	Insulation	Insulation class F		
	Winding protection	3 PTC thermistors, 155 °C		
Rotor winding	Material	Die-cast aluminum		
Balancing method		Half key balancing		
Keyway		Closed key way		
Heating elements	On request	60 W	2x60 W	2x60 W
Enclosure		IP 55		
Cooling method		IC 411		
Drain holes		Drain holes with closable plastic plugs, open on delivery		
Lifting lugs		Bolted to the stator		

IE2 General performance aluminum motors

Sizes 56 to 250, 0.06 to 55 kW

Ordering information	48
3000 r/min motors.....	49
1500 r/min motors.....	50
1000 r/min motors.....	51
Variant codes	52
Dimension drawings	54
Motors in brief	55
Motor sizes 56 - 132.....	55
Motor sizes 160 - 250.....	56

Ordering information

Explanation of the product code

Motor type	Motor size	Product code	Mounting arrangement code, Voltage and frequency code, Generation code	Variant codes
M2AA	112MB	3GAA 113 212 - ADE		122, etc.
		1 2 3 4 5 6 7 8 9 10 11 12 13 14		

When placing an order, please state the following minimum data in the order, as in example

The product code of the motor is composed in accordance with the following example.

Example

Motor type	M2AA 112 MB
Pole number	6
Mounting arrangement (IM-code)	IM B3 (IM 1001)
Rated output	2.2 kW
Product code	3GAA 113 212-ADE
Variant codes if needed	

Positions 1 to 4

3GAA: : Totally enclosed motor with aluminum stator frame

Positions 5 and 6

IEC size	
05:	56
06:	63
07:	71
08:	80
09:	90
10:	100
11:	112
13:	132
16:	160
18:	180
20:	200
22:	225
25:	250

Position 7

Pole pairs	
1:	2 poles
2:	4 poles
3:	6 poles

Positions 8 to 10

Running number

Position 11

- (dash)

Position 12

Mounting arrangement

A:	Foot-mounted motor
B:	Flange-mounted motor. Large flange with clearance holes.
C:	Flange-mounted motor. Small flange with tapped holes.
F:	Foot- and flange-mounted motor. Special flange.
H:	Foot- and flange-mounted motor. Large flange with clearance holes.
J:	Foot- and flange-mounted motor. Small flange with tapped holes.
N:	Flange-mounted (CI ring flange FF)
P:	Foot-and flange-mounted motor (CI ring flange FF)

Position 13

Voltage and frequency

Single-speed motors

D:	400 VΔ, 415 VΔ, 460 VΔ, 690 VY 50 Hz
S:	230 VΔ, 400 VY, 415 VY 50 Hz, 460 VΔ 60 Hz*)

Position 14

Version **A, B, C...** = Generation code followed by variant codes

*) M2AA 200 is not available for voltages less than 380 VD

Efficiency values are given according to IEC 60034-2-1; 2014

For detailed dimension drawings please see our web-pages 'www.abb.com/motors&generators' or contact ABB.

Technical data

IE2 General performance aluminum motors, 3000 r/min

IP 55 - IC 411 - Insulation class F, temperature rise class B
IE1 efficiency class according to IEC 60034-30-1; 2014

Output kW	Motor type	Product code	Speed r/min	Efficiency IEC 60034-30-1; 2014			Power factor Cos ϕ	Current Torque					Moment of inertia J = 1/4 GD ² kgm ²	Weight kg	Sound pressure Level L _{PA} dB
				Full load 100%	3/4 load 75%	1/2 load 50%		I _N A	I _s /I _N	T _N Nm	T _f /T _N	T _b /T _N			
3000 r/min = 2 poles				400 V 50 Hz				GENELEC-design							
0.09	M2AA 56A 2	3GAA051001-••E	2800	55,6	50,8	38,7	0,67	0,35	3,5	0,29	2,4	2,6	0,000100	2,6	56
0.12	M2AA 56B 2	3GAA051002-••E	2830	61,8	58,3	48,3	0,68	0,41	4,3	0,40	2,5	2,8	0,000130	3,0	57
0.18	M2AA 63A 2	3GAA061001-E	2790	67,3	65,1	58,2	0,75	0,51	4,5	0,61	2,4	2,6	0,000150	4,0	60
0.25	M2AA 63B 2	3GAA061002-E	2790	71,4	70,1	64,7	0,76	0,66	4,8	0,86	2,8	2,7	0,000170	4,2	61
0.37	¹⁾ M2AA 71A 2	3GAA071001-••E	2800	73,8	75,8	73,9	0,76	0,95	4,9	1,26	2,7	2,7	0,000350	4,9	58
0.55	¹⁾ M2AA 71B 2	3GAA071002-••E	2790	78,4	79,8	78,7	0,78	1,29	5,3	1,88	2,9	2,8	0,000450	5,9	58
0.75	M2AA 80B 2	3GAA081212-••E	2895	80,6	80,4	77,3	0,79	1,7	8,1	2,4	3,7	3,9	0,00090	10,5	60
1.1	M2AA 80C 2	3GAA081213-••E	2875	80,6	80,4	77,9	0,80	2,4	7,8	3,6	3,6	3,5	0,00120	11	60
1.5	M2AA 90L 2	3GAA091212-••E	2900	84,1	85,0	83,5	0,86	2,9	7,6	4,9	2,5	3,3	0,00240	16	60
2.2	M2AA 90LB 2	3GAA091213-••E	2875	84,6	85,7	85,5	0,85	4,4	6,9	7,3	2,8	3,2	0,00270	18	63
3	M2AA 100LB 2	3GAA101212-••E	2920	86,4	86,1	84,0	0,86	5,8	9,3	9,8	3,3	3,9	0,0050	25	62
4	M2AA 112MB 2	3GAA111212-••E	2885	86,1	87,0	88,0	0,88	7,6	7,6	13,2	2,5	2,8	0,00620	30	68
5.5	M2AA 132SB 2	3GAA131212-••E	2915	88,0	88,1	86,9	0,82	11,0	7,9	18,0	2,6	3,6	0,0160	42	73
7.5	M2AA 132SC 2	3GAA131213-••E	2915	88,5	89,1	88,5	0,88	13,6	7,6	24,5	2,2	3,2	0,0220	56	73
11	M2AA 160MLA 2	3GAA161410-••F	2920	89,8	90,2	89,8	0,89	19,8	5,9	35,9	1,6	2,7	0,0380	83	69
15	M2AA 160MLB 2	3GAA161420-••F	2934	91,1	90,6	90,0	0,90	26,4	7,0	48,8	2,5	3,1	0,0480	96	69
18.5	M2AA 160MLC 2	3GAA161430-••F	2934	90,9	90,4	89,3	0,89	32,9	7,3	60,2	2,6	3,2	0,0520	104	73
22	M2AA 180MLA 2	3GAA181410-••F	2933	91,5	92,2	91,9	0,90	38,1	7,8	71,6	3,0	3,5	0,0620	123	73
30	M2AA 200MLA 2	3GAA201410-••F	2948	92,2	91,9	91,3	0,89	52,7	7,8	97,1	2,7	3,3	0,0920	160	75
37	¹⁾ M2AA 200MLB 2	3GAA201420-••F	2947	92,5	93,0	92,7	0,90	64,3	7,7	119	2,8	3,6	0,116	186	75
45	M2AA 225SMA 2	3GAA221210-••F	2960	93,0	93,6	92,8	0,90	79,2	8,1	145	3,1	3,4	0,197	244	75
55	M2AA 250SMA 2	3GAA251210-••F	2963	93,9	94,4	93,7	0,89	94,4	6,8	177	2,6	2,5	0,275	308	75

¹⁾ Temperature rise class F

Technical data

IE2 General performance aluminum motors, 1500 r/min

IP 55 - IC 411 - Insulation class F, temperature rise class B
IE1 efficiency class according to IEC 60034-30-1; 2014

Output kW	Motor type	Product code	Speed r/min	Efficiency IEC 60034-30-1; 2014			Power factor Cosφ	Current Torque					Moment of inertia J = 1/4 GD ² kgm ²	Weight kg	Sound pressure Level L _{PA} dB
				Full load 100%	3/4 load 75%	1/2 load 50%		I _N A	I _s /I _N	T _N Nm	T _i /T _N	T _b /T _N			
1500 r/min = 4 poles				400 V 50 Hz				GENELEC-design							
0.06	M2AA 56A 4	3GAA052001-E	1390	52,8	49,6	40,8	0,54	0,30	3,2	0,41	3,2	3,3	0,000190	2,9	47
0.09	M2AA 56B 4	3GAA052002-E	1400	53,0	49,2	40,8	0,59	0,39	3,1	0,62	2,3	2,8	0,000240	3,2	48
0.12	M2AA 63A 4	3GAA062001-E	1360	55,0	51,3	43,0	0,64	0,49	3,2	0,84	2,4	2,5	0,000270	3,7	51
0.18	M2AA 63B 4	3GAA062002-E	1370	63,5	61,0	54,3	0,61	0,67	3,7	1,25	2,8	2,9	0,000340	4,2	54
0.25	M2AA 71A 4	3GAA072001-••E	1365	65,1	66,0	62,7	0,76	0,72	4,0	1,74	2,0	2,1	0,000660	5,2	45
0.37	¹⁾ M2AA 71B 4	3GAA072002-••E	1375	69,7	71,9	71,1	0,79	0,96	3,8	2,5	2,0	2,2	0,00080	5,9	45
0.55	¹⁾ M2AA 80A 4	3GAA082001-••E	1375	72,8	76,1	75,2	0,77	1,41	4,5	3,8	1,8	2,2	0,00130	8,5	50
0.75	M2AA 80D 4	3GAA082214-••E	1415	79,8	81,3	79,9	0,82	1,65	5,9	5,0	2,6	3,2	0,00160	12	50
0.75	M2AA 80E 4	3GAA082215-••E	1425	79,8	80,4	77,9	0,72	1,88	6,6	5,0	3,5	3,6	0,0020	15	54
1.1	M2AA 90LB 4	3GAA092214-••E	1435	83,7	84,1	83,0	0,78	2,4	6,6	7,3	2,9	3,2	0,00430	16	50
1.5	M2AA 90LD 4	3GAA092215-••E	1435	84,2	84,1	81,9	0,76	3,3	7,0	9,9	3,1	3,5	0,00480	17	50
2.2	M2AA 100LC 4	3GAA102213-••E	1450	86,4	86,2	84,1	0,79	4,6	7,3	14,4	2,8	3,4	0,0090	25	54
3	M2AA 100LD 4	3GAA102214-••E	1445	85,7	86,1	85,1	0,79	6,3	7,0	19,8	2,4	3,0	0,0110	28	63
4	M2AA 112MB 4	3GAA112212-••E	1445	86,7	86,5	85,2	0,75	8,8	7,3	26,4	3,1	3,4	0,0126	34	64
5.5	M2AA 132M 4	3GAA132212-••E	1465	89,0	89,5	88,6	0,79	10,9	6,3	36,0	1,9	2,6	0,0380	48	66
7.5	M2AA 132MA 4	3GAA132214-••E	1460	89,1	89,8	89,4	0,79	14,7	6,4	49,0	1,8	2,6	0,0480	59	63
11	M2AA 160MLA 4	3GAA162410-••F	1463	90,1	91,7	91,4	0,85	20,7	7,1	71,7	2,6	3,0	0,0840	97	65
15	M2AA 160MLB 4	3GAA162420-••F	1463	90,6	92,1	91,9	0,84	28,4	7,2	97,9	2,7	3,6	0,0950	105	65
18.5	M2AA 180MLA 4	3GAA182410-••F	1464	91,2	92,0	91,6	0,84	34,8	7,9	120	3,1	3,6	0,112	125	62
22	M2AA 180MLB 4	3GAA182420-••F	1465	91,6	92,2	91,8	0,83	41,7	8,0	143	3,0	3,8	0,130	137	65
30	M2AA 200MLA 4	3GAA202410-••F	1474	92,2	93,6	93,7	0,83	56,5	7,3	194	2,7	2,9	0,217	188	62
37	M2AA 225SMA 4	3GAA222210-••F	1478	93,0	93,9	93,8	0,84	68,6	7,2	238	2,6	2,9	0,309	239	68
45	M2AA 225SMB 4	3GAA222220-••F	1479	92,9	93,7	93,4	0,83	83,9	7,4	290	2,4	3,1	0,368	265	68
55	M2AA 250SMA 4	3GAA252210-••F	1478	93,5	94,3	93,8	0,85	99,1	7,3	355	2,8	3,0	0,476	311	70

¹⁾ Temperature rise class F

Technical data

IE2 General performance aluminum motors, 1000 r/min

IP 55 - IC 411 - Insulation class F, temperature rise class B
IE2 efficiency class according to IEC 60034-30-1; 2014

Output kW	Motor type	Product code	Speed r/min	Efficiency IEC 60034-30-1; 2014			Power factor Cos ϕ	Current Torque					Moment of inertia J = 1/4 GD ² kgm ²	Weight kg	Sound pressure Level L _{PA} dB
				Full load 100%	3/4 load 75%	1/2 load 50%		I _N A	I _s /I _N	T _N Nm	T _f /T _N	T _b /T _N			
1000 r/min = 6 poles				400 V 50 Hz				CENELEC-design							
0.09	M2AA 63A 6	3GAA063001-E	890	50,7	48,5	42,0	0,62	0,41	2,8	0,96	2,0	2,2	0,000420	4,2	48
0.12	M2AA 63B 6	3GAA063002-E	890	52,3	48,8	41,5	0,60	0,55	3,0	1,29	2,2	2,4	0,000520	4,5	53
0.18	¹⁾ M2AA 71A 6	3GAA073001-••E	885	59,5	61,1	56,5	0,71	0,61	3,1	1,94	1,7	1,9	0,000920	5,5	42
0.25	¹⁾ M2AA 71B 6	3GAA073002-••E	895	64,0	63,6	59,5	0,71	0,79	3,3	2,6	2,2	2,2	0,00120	6,5	42
0.37	¹⁾ M2AA 80A 6	3GAA083001-••E	905	68,0	70,7	68,3	0,73	1,07	3,6	3,9	1,6	2,1	0,0020	9	47
0.55	M2AA 80B 6	3GAA083002-••E	905	68,7	71,8	69,7	0,73	1,58	3,3	5,8	1,6	1,8	0,00260	10	47
0.75	M2AA 90LB 6	3GAA093213-••E	930	77,6	76,2	75,6	0,71	1,96	4,0	7,7	2,0	2,3	0,00480	18	44
1.1	M2AA 90LD 6	3GAA093214-••E	935	78,2	79,2	77,5	0,66	2,94	4,2	11,2	2,2	2,6	0,00560	20	44
1.5	M2AA 100LC 6	3GAA103212-••E	945	80,3	81,4	80,7	0,73	3,6	3,9	15,1	1,7	2,0	0,0090	26	49
2.2	M2AA 112MB 6	3GAA113212-••E	955	81,9	81,8	79,2	0,72	5,3	5,2	21,9	1,8	2,2	0,010	28	56
3	M2AA 132S 6	3GAA133211-••E	960	83,3	82,9	80,5	0,65	7,69	4,3	29,8	1,6	2,3	0,0310	39	57
4	M2AA 132MB 6	3GAA133213-••E	975	86,4	85,8	83,1	0,70	9,4	7,3	39,2	2,1	4,4	0,0450	54	57
5.5	M2AA 132MC 6	3GAA133214-••E	965	86,1	85,6	83,0	0,67	13,3	6,2	54,3	2,5	2,8	0,0490	59	61
7.5	M2AA 160MLA 6	3GAA163410-••F	971	87,6	88,8	88,7	0,79	15,6	7,1	73,7	1,9	3,3	0,089	105	61
11	M2AA 160MLB 6	3GAA163420-••F	970	88,7	88,0	88,0	0,79	22,3	7,6	108	2,1	3,3	0,119	121	61
15	M2AA 180MLA 6	3GAA183410-••F	971	89,7	90,9	90,6	0,76	31,7	7,8	147	2,5	4,1	0,137	139	61
18.5	M2AA 200MLA 6	3GAA203410-••F	975	90,7	91,5	91,1	0,79	37,1	5,9	181	1,7	2,7	0,198	173	65
22	M2AA 200MLB 6	3GAA203420-••F	974	91,0	91,8	91,7	0,79	44,1	5,8	216	1,8	2,6	0,222	184	65
30	M2AA 225SMA 6	3GAA223210-••F	986	92,2	93,3	93,3	0,83	57,2	6,9	290	2,4	2,8	0,532	265	65
37	M2AA 250SMA 6	3GAA253210-••F	985	92,3	93,3	93,0	0,82	70,4	6,6	358	2,4	2,8	0,718	305	66

¹⁾ Temperature rise class F

Variant codes

IE2 General performance aluminum motors

Variant codes specify additional options and features to the standard motor. The desired features are listed as three-digit variant codes in the motor order. Note also that there are variants that cannot be used together.

Code/Variants, M2AA	Frame size												
	56	63	71	80	90	100	112	132	160	180	200	225	250
Bearings and Lubrication													
037	Roller bearing at D-end.	-	-	-	-	-	-	-	•	•	•	•	•
040	Heat-resistant grease	-	-	•	•	•	•	•	-	-	-	-	-
041	Bearings regreasable via grease nipples.	-	-	-	-	-	-	-	•	•	•	•	•
043	SPM compatible nipples for vibration measurement	-	-	-	-	•	•	•	•	•	•	•	•
188	63-series bearing in D-end	-	-	-	-	•	○	○	•	•	•	•	•
Branch standard designs													
178	Stainless steel / acid proof bolts.	•	•	•	•	•	•	•	•	•	•	•	•
217	Cast iron D-end shield (on aluminum motor).	-	-	•	•	•	•	•	○	○	○	○	○
265	Assembly of line # to #	-	-	•	•	•	•	•	•	•	•	•	•
Cooling system													
053	Metal fan cover.	-	-	•	•	•	•	•	-	-	-	-	-
068	Light alloy metal fan	-	-	•	•	•	•	•	•	•	•	•	•
Documentation													
141	Binding dimension drawing.	•	•	•	•	•	•	•	•	•	•	•	•
Drain holes													
065	Plugged existing drain holes.	•	•	•	•	•	•	•	•	•	•	•	•
Earthing Bolt													
067	External earthing bolt.	•	•	•	•	•	•	•	•	•	•	•	•
Heating elements													
450	Heating element, 100-120 V	•	•	•	•	•	•	•	•	•	•	•	•
451	Heating element, 200 - 240 V	•	•	•	•	•	•	•	•	•	•	•	•
Marine													
096	Fulfilling Lloyds Register of Shipping (LR) requirements, without certificate (non-essential duty only)	-	-	•	•	•	•	•	•	•	•	•	•
186	Fulfilling Det Norske Veritas (DNV) requirements, without certificate (non-essential duty only)	-	-	•	•	•	•	•	•	•	•	•	•
492	Fulfilling Registro Italiano Navale (RINA) requirements, without certificate.	-	-	•	•	•	•	•	•	•	•	•	•
496	Fulfilling Bureau Veritas (BV) requirements, without certificate(non-essential duty only)	-	-	•	•	•	•	•	•	•	•	•	•
675	Fulfilling American Bureau of Shipping (ABS) requirements, without certificate (non-essential duty only)	-	-	•	•	•	•	•	•	•	•	•	•
676	Fulfilling Germanischer Lloyd (GL) requirements, without certificate (non-essential duty only)	-	•	•	•	•	•	•	•	•	•	•	•
Mounting arrangements													
008	IM 2101 foot/flange mounted, IEC flange, from IM 1001 (B34 from B3).	•	•	•	•	•	•	•	•	-	-	-	-
009	IM 2001 foot/flange mounted, IEC flange, from IM 1001 (B35 from B3).	•	•	•	•	•	•	•	•	•	•	•	•
047	IM 3601 flange mounted, IEC flange, from IM 3001 (B14 from B5).	•	•	•	•	•	•	•	•	-	-	-	-
048	IM 3001 flange mounted, IEC flange, from IM 3601 (B5 from B14).	•	•	•	•	•	•	•	•	-	-	-	-
066	Modified for specified mounting position differing from IM B3 (1001), IM B5 (3001), B14 (3601), IM B35 (2001), IM B34 (2101)	•	•	•	•	•	•	•	•	•	•	•	•
200	Flange ring holder.	-	-	•	•	•	•	•	-	-	-	-	-
218	Flange ring FT 85.	-	-	•	•	•	-	-	-	-	-	-	-
219	Flange ring FT 100.	-	-	•	•	•	-	-	-	-	-	-	-
220	Flange ring FF 100.	-	-	•	•	•	-	-	-	-	-	-	-
223	Flange ring FF 115.	-	-	•	•	•	-	-	-	-	-	-	-
224	Flange ring FT 115.	-	-	•	•	•	-	-	-	-	-	-	-
226	Flange ring FF 130.	-	-	•	•	•	•	-	-	-	-	-	-
227	Flange ring FT 130.	-	-	•	•	•	•	-	-	-	-	-	-
233	Flange ring FF 165.	-	-	-	•	•	•	-	-	-	-	-	-
234	Flange ring FT 165.	-	-	•	•	•	•	-	-	-	-	-	-
236	Flange FT 165.	-	-	-	-	-	-	•	-	-	-	-	-
243	Flange ring FF 215.	-	-	-	-	-	•	•	-	-	-	-	-
244	Flange ring FT 215.	-	-	-	-	-	-	•	-	-	-	-	-
253	Flange ring FF 265.	-	-	-	-	-	-	-	•	-	-	-	-
254	Flange ring FT 265.	-	-	-	-	-	-	-	•	-	-	-	-

○ = Included as standard | • = Available as option | - = Not applicable

Code/Variants, M2AA	Frame size												
	56	63	71	80	90	100	112	132	160	180	200	225	250
255 Flange FF 265.	-	-	-	-	-	-	-	•	-	-	-	-	-
Painting													
114 Special paint color, standard grade	•	•	•	•	•	•	•	•	•	•	•	•	•
Protection													
005 Protective roof, vertical motor, shaft down.	•	•	•	•	•	•	•	•	•	•	•	•	•
072 Radial seal at D-end. Not possible for 2-pole , 280 and 315 frames	-	-	•	•	•	•	•	•	•	•	•	•	•
Rating & instruction plates													
002 Restamping voltage, frequency and output, continuous duty.	•	•	•	•	•	•	•	•	•	•	•	•	•
095 Restamping output (maintained voltage, frequency), intermittent duty.	•	•	•	•	•	•	•	•	•	•	•	•	•
098 Stainless rating plate.	-	-	-	-	-	-	-	-	•	•	•	•	•
135 Mounting of additional identification plate, stainless.	-	-	•	•	•	•	•	•	•	•	•	•	•
159 Additional plate with text "Made in ..."	•	•	•	•	•	•	•	•	•	•	•	•	•
161 Additional rating plate delivered loose.	•	•	•	•	•	•	•	•	•	•	•	•	•
332 Baldor Catalogue #	•	•	•	•	-	-	-	-	-	-	-	-	-
Standards and Regulations													
331 IE1 motor not for sale for use in EU	-	-	-	•	•	•	•	•	•	•	•	•	•
540 China energy label	-	-	-	-	-	-	-	-	•	•	•	•	•
Stator winding temperature sensors													
122 Bimetal detectors, break type (NCC), (3 in series), 150 °C, in stator winding	•	•	•	•	•	•	•	•	•	•	•	•	•
435 PTC - thermistors (3 in series), 130 °C, in stator winding	•	•	•	•	•	•	•	•	•	•	•	•	•
436 PTC - thermistors (3 in series), 150 °C, in stator winding	•	•	•	•	•	•	•	•	•	○	○	○	○
441 PTC - thermistors (3 in series, 130 °C & 3 in series, 150 °C), in stator winding	-	-	-	-	•	•	•	•	•	•	•	•	•
445 Pt100 2-wire in stator winding, 1 per phase	-	-	-	-	-	-	-	-	•	•	•	•	•
Terminal box													
230 Standard metal cable gland.	•	•	•	•	•	•	•	•	•	•	•	•	•
375 Standard plastic cable gland	-	-	•	•	•	•	•	•	-	-	-	-	-
Testing													
145 Type test report from a catalogue motor, 400V 50Hz.	•	•	•	•	•	•	•	•	•	•	•	•	•
148 Routine test report.	•	•	•	•	•	•	•	•	•	•	•	•	•
Variable speed drives													
704 EMC cable entry.	•	•	•	•	•	•	•	•	•	•	•	•	•

○ = Included as standard | • = Available as option | - = Not applicable

Dimension drawings

IE2 General performance aluminum motors, sizes 56 - 250

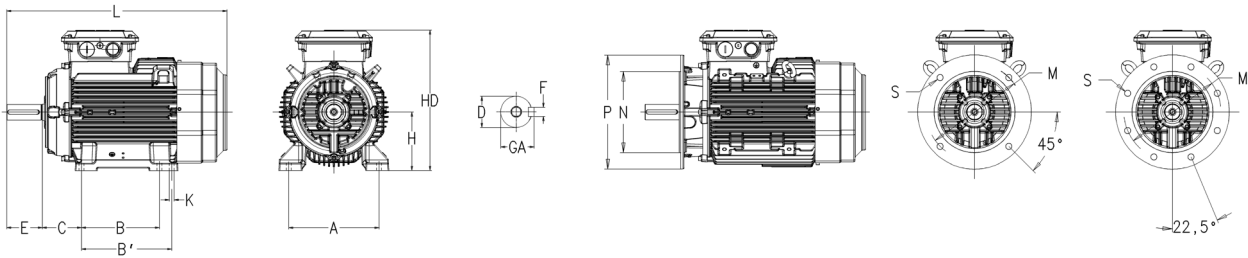

Foot-mounted motor IM1001, B3 and Flange-mounted motor IM 3001, B5

General performance aluminum motors

Motor size	D poles		GA poles		F poles		E poles		L max poles		A	B	B'	C	HD	K	H	M	N	P	S
	2	4-6	2	4-6	2	4-6	2	4-6	2	4-6											
M2AA 56	9	9	102	102	3	3	20	20	196	196	90	71	-	36	152	5.8	56	100	80	120	7
63	11	11	125	125	4	4	23	23	220	220	100	80	-	40	170	7	63	115	95	140	10
71	14	14	16	16	5	5	30	30	240	240	112	90	-	45	180	7	71	130	110	160	10
80	19	19	215	215	6	6	40	40	2655	2655	125	100	-	50	193.5	10	80	165	130	200	12
90 S	24	24	27	27	8	8	50	50	2845	2845	140	100	-	56	217	10	90	165	130	200	12
90 L	24	24	27	27	8	8	50	50	3095	3095	140	125	-	56	217	10	90	165	130	200	12
100	28	28	31	31	8	8	60	60	351	351	160	140	-	63	237	12	100	215	180	250	15
112	28	28	31	31	8	8	60	60	393	393	190	140	-	70	249	12	112	215	180	250	15
132 ¹⁾	38	38	41	41	10	10	80	80	447	447	216	140	178	89	295.5	12	132	265	230	300	14.5
132 ²⁾	38	38	41	41	10	10	80	80	550	550	216	140	178	89	321	15	132	265	230	300	14.5
160	42	42	45	45	12	12	110	110	584	584 ³⁾	254	210	254	108	370	14.5	160	300	250	350	19
180	48	48	515	515	14	14	110	110	681	681	279	241	279	121	390	14.5	180	300	250	350	19
200	55	55	59	59	16	16	110	110	726	726	318	267	305	133	425	18.5	200	350	300	400	19
225	55	60	59	64	16	18	110	140	821	851	356	286	311	149	525 ⁴⁾	18	225	400	350	450	19
250	60	65	64	69	18	18	140	140	880	880	406	311	349	168	572 ⁴⁾	22	250	500	450	550	19

Motor size	M	N	P	S	Tolerances	Footnotes
56	65	50	80	M5	A, B ±0,8	1) All types except M2A SC 2 pole,
63	75	60	90	M5	D ISO j6 ≤ Ø 28 mm	MC 6 pole
71	85	70	105	M6	ISO k6 < Ø 38 mm	2) M2AA 132 SC 2 pole and MC 6 pole
80	100	80	120	M6	ISO m6 ≥ Ø 55 mm	3) 160MLB 6-pole L = 681
90	115	95	140	M8	F ISO h9	4) For voltage code S add 32 mm
100	130	110	160	M8	H -0,5	to listed HD-dimension
112	130	110	160	M8	N ISO js6	5) 160MLB 6-pole L = 681
132 ¹⁾	165	130	200	M10	C ±0,8	6) 200, voltage code S HD = 478

Motors in brief

IE2 General performance aluminum motors, sizes 56 - 132

Size	M2AA	56	63	71	80	90	100	112	132	
Stator	Material	Die-cast aluminum alloy								
	Paint color shade	Munsell blue 8B 4.5/3.25 / NCS 4822 B05G								
	Surface treatment	Epoxy polyester powder paint, $\geq 60\mu\text{m}$				Polyester powder paint, $\geq 60\mu\text{m}$				
Feet	Material	Detachable aluminum feet			Integrated aluminum feet					
Bearing end shields	Material	Die-cast aluminum alloy								
	Paint color shade	Munsell blue 8B 4.5/3.25								
	Surface treatment	Epoxy polyester powder paint, $\geq 60\mu\text{m}$				Polyester powder paint, $\geq 60\mu\text{m}$				
Bearings	D-end	6201-2Z/C3	6202-2Z/C3	6203-2Z/C3	6204-2Z/C3	6205-2Z/C3	6306-2Z/C3	6306-2Z/C3	6208-2Z/C3 ¹⁾	
	N-end	6201-2Z/C3	6201-2Z/C3	6202-2C/C3	6203-2Z/C3	6204-2Z/C3	6205-2Z/C3	6205-2Z/C3	6206-2Z/C3	
Axially locked bearings	Inner bearing cover	D-end internal retaining ring				D-end				
Bearing seals	D-end	V-ring								
	N-end	Labyrinth seal								
Lubrication		Permanently lubricated shielded bearings.								
Terminal box	Material	Die-cast aluminum alloy, base integrated with stator								
	Surface treatment	Die-cast aluminum alloy								
	Screws	Steel 5G, galvanised.								
Connections	Knock-out openings	1 x M16 x Pg11		2 x (M20 + M20)		2 x (M20 + M25) ²⁾				
	Max Cu-area mm ²	2.5		4		6				
	Terminal box	Cable lugs, 6 terminals				6 screw terminals				
Fan	Material	Polypropylene. Reinforced with 20% glass fibre.								
Fan cover	Material	Polypropylene								
Stator winding	Material	Copper								
	Insulation	Insulation class F								
	Winding protection	Optional								
Rotor winding	Material	Die-cast aluminum								
Balancing method		Half-key balancing								
Key ways		Closed key way								
Heating elements	Optional	8 W				25 W				
Enclosure		IP 55								
Cooling method		IC 411								
Drain holes		Drain holes with closable plastic plugs, open on delivery.								
Lifting lugs		Integrated with the stator								

Motors in brief

IE2 General performance aluminum motors, sizes 160 - 250

Size	M2AA	160	180	200	225	250
Stator	Material	Die-cast aluminum alloy			Extruded aluminum alloy	
	Paint colour shade	Munsell blue 8B 4.5/3.25				
	Surface treatment	Polyester powder paint, $\geq 60\mu\text{m}$				
Feet		Detachable feet				
	Material	Aluminum alloy			Cast iron	
Bearing end shields	Material	Cast iron EN-GJL-200/GG 20/GRS 200				
	Paint colour shade	Munsell blue 8B 4.5/3.25 / NCS 4822 B05G				
	Surface treatment	Two-pack epoxy pain paint, $\geq 60\mu\text{m}$				
Bearings	D-end	6209-2Z/C3	6210-2Z/C3	6212-2Z/C3	6213-2Z/C3	6215-2Z/C3
	N-end	6209-2Z/C3	6209-2Z/C3	6209-2Z/C3	6210-2Z/C3	6212-2Z/C3
Axially-locked	Inner bearing cover	D-end				
Bearing seals		Axial seal				
Lubrication		Permanently lubricated shielded bearings.				
Terminal box	Material	Die-cast aluminum alloy, base integrated with stator.			Deep-drawn steel sheet, bolted to stator.	
	Surface treatment	Polyester powder paint, $\geq 60\mu\text{m}$			Phosphated. Polyester paint.	
	Screws	Steel 8.8, zinc electroplated and chromated				
Connections	Knock-out openings				2 x FL13, 2 x M40	
	Flange openings	(2 x M40 + M16) + (2 x M40)			2 x FL 21, 2 x M63 (voltage code S)	
	Max Cu-area mm ²	35			70	
	Terminal box	6 terminals for connection with cable lugs (not included)				
	Screws	M6			M10	
Fan	Material	Polypropene. Reinforced with 20% glass fibre.				
Fan cover	Material	Hot dip galvanized steel				
	Paint colour shade	Black, NCS 8801-B09G				
	Surface treatment	Polyester powder paint, $\geq 60\mu\text{m}$				
Stator winding	Material	Copper				
	Insulation class	Insulation class F				
	Winding protection	3 PTC thermistors as standard, 150°C				
Rotor winding	Material	Diecast aluminum				
Balancing method		Half key balancing				
Key Ways		Closed key way				
Heating elements	Optional	25 W			50W	
Enclosure		IP 55				
Cooling method		IC 411				
Drain holes		Drain holes with closable plastic plugs, open on delivery.				
Lifting lugs		Integrated with the stator			Bolted to the stator	

Total product offering

Motors, generators and mechanical power transmission products with a complete portfolio of services



ABB is the leading manufacturer of low, medium and high voltage motors and generators, and mechanical power transmission products. ABB products are backed by a complete portfolio of services. Our in-depth knowledge of virtually every type of industrial process ensures we always specify the best solution for your needs.

Low and high voltage IEC induction motors

- Process performance motors
- General performance motors
- High voltage cast iron motors
- Induction modular motors
- Slip-ring modular motors

Low and medium voltage NEMA motors

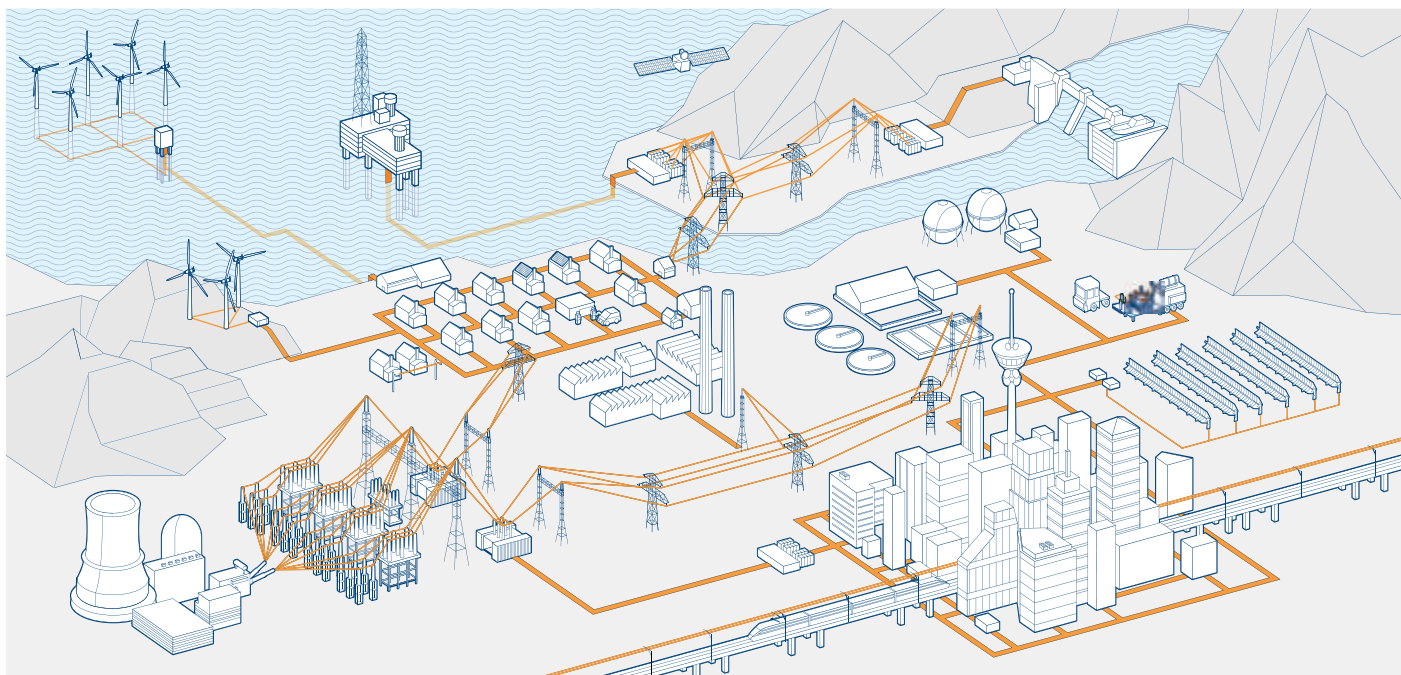
- Steel frame open drip proof (ODP) motors
- Weather protected, water cooled, fan ventilated
- Cast iron frame (TEFC)
- Air to air cooled (TEAAC) motors

Motors and generators for explosive atmospheres

- IEC and NEMA motors and generators, for all protection types

Synchronous motors

Synchronous generators

- Synchronous generators for diesel and gas engines
- Synchronous generators for steam and gas turbines

Wind power generators

Generators for small hydro

Other motors and generators

- Brake motors
- DC motors and generators
- Gear motors
- Marine motors and generators
- Single phase motors
- Motors for high ambient temperatures
- Synchronous reluctance motors
- Permanent magnet motors and generators
- High speed motors
- Smoke extraction motors
- Wash down motors
- Water cooled motors
- Generator sets
- Roller table motors
- Low inertia motors
- Traction motors and generators

Life cycle services

Mechanical power transmission components, bearings, gearings

Life cycle services and support

From pre-purchase to migration and upgrades



ABB offers a complete portfolio of services to ensure trouble-free operation and long product lifetimes. These services cover the entire life cycle. Local support is provided through a global network of ABB service centers and certified partners.

Pre-purchase

ABB's front-end sales organization can help customers to quickly and efficiently select, configure and optimize the right motor or generator for their application.

Installation and commissioning

Professional installation and commissioning by ABB's certified engineers represent an investment in availability and reliability over the entire life cycle.

Engineering and consulting

ABB's experts provide energy efficiency and reliability appraisals, advanced condition and performance assessments and technical studies.

Condition monitoring and diagnosis

Unique services collect and analyze data to provide early warnings of problems before failures can occur. All critical areas of the equipment are covered.

Maintenance and field services

ABB offers life cycle management plans and preventive maintenance products. The recommended four-level maintenance program covers the entire product lifetime.

Spare parts

Spare parts and support are offered throughout the life cycle of ABB products. In addition to individual spares, tailored spare part packages are also available.

Repair and refurbishment

Support for all ABB motors and generators and other brands is provided by ABB's global service organization. Specialist teams can also deliver emergency support.

Migration and upgrades

Life cycle audits determine the optimum upgrades and migration paths. Upgrades range from individual components to direct replacement motors and generators.

Training

Product and service training courses take a practical approach. The training ranges from standard courses to specially tailored programs to suit customer requirements.

Specialized support

Specialized support is offered through ABB's global service organization. Local units provide major and minor repairs as well as overhauls and reconditioning.

Service contracts

Service contracts are tailored to the customer's needs. The contracts combine ABB's entire service portfolio and 120 years of experience to deploy the optimal service practices.

Contact us

www.abb.com/motors&generators

We reserve the right to make technical changes or modify the contents of this document without prior notice. With regard to purchase orders, the agreed particulars shall prevail. ABB does not accept any responsibility what so ever for potential errors or possible lack of information in this document.

We reserve all rights in this document and in the subject matter and illustrations contained herein. Any reproduction, disclosure to third parties or utilization of its contents – in whole or in parts – is forbidden without prior written consent of ABB.

© Copyright 2015 ABB.

All rights reserved.

